



1250 Michigan Avenue, Chicago, IL

> Specify
Quality

Window & Balcony Door Systems



Entrances | Storefronts | Curtain Wall | Windows | Sun Controls | Balcony Doors



Quality
inspires™

YKK AP America — The Company



YKK AP maintains a state-of-the-art ISO 14001 certified manufacturing facility in Dublin, Georgia.

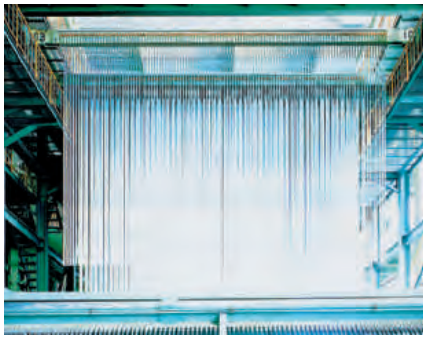

The Architectural Products division of YKK is today a world leader in the manufacture of aluminum building products. YKK AP is committed to producing architectural products of the highest quality and at the lowest possible cost. To this end, YKK AP

has built one of the newest and most technologically advanced manufacturing facilities in the United States in Dublin, Georgia. There, all manufacturing is vertically integrated to ensure control of quality, delivery and cost.

YKK AP America's slogan "Quality inspires™", expresses our belief that quality goes far beyond the products we ship from the plant. Quality is the driver behind every YKK AP product — including every action, every process and every service for every YKK AP customer.

To provide years of dependable use, a new building must have excellence built-in from the beginning. That is why architects, developers and construction engineers are specifying architectural aluminum entrance, storefront, curtain wall, window and balcony door systems from YKK AP.

YKK AP has a long track record of enhancing the exterior envelope of all types of buildings, including office buildings, stadiums, malls, schools, hospitals, hotels, condominiums, and more. Our products ensure users a safe, sustainable and comfortable environment. For example, YKK AP pioneered the introduction of **YKK AP ProTek™** — a unique family of systems that mitigate risks associated with natural and man-made disasters.

As Architects and builders employ "green" design, they are turning to YKK AP for custom-crafted, sustainable building products.

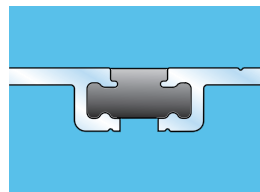

ThermoBond Plus®

(poured and debridged thermal break)

Combining science and technology, YKK AP employs a patented process, ThermoBond Plus, to greatly improve the adhesion of the polyurethane to the aluminum extrusion.

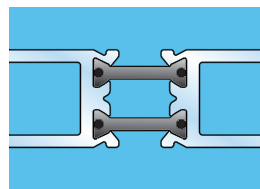

MegaTherm®

YKK AP also offers an integral thermal barrier system that employs the use of 6/6 nylon polyamide glass fiber reinforced pressure extruded bars. This has several advantages over the more commonly used poured and debridged

polyurethane barriers. It will not shrink or degrade over time. It will not crack if penetrated by screws or if weep holes are cut into it. Its lineal expansion is very close to that of aluminum, virtually eliminating creeping, thermal expansion and internal stresses. It also offers greater design versatility by allowing the use of different finish options from interior to exterior surfaces.

Anodized Plus®

YKK AP has the only finish that meets all of the requirements of AAMA 612, the newest standard for anodized finishes. It combines the beauty of anodizing with performance characteristics that resist damage from mortar, alkali and other chemicals. Your building is protected from harsh construction conditions as well as other environmental elements for the lifetime of the building. Anodized Plus is available in clear, dark bronze, medium bronze, black, champagne and white finishes.

In addition, YKK AP offers a variety of painted finishes that are applied at our environmentally friendly Dublin facility which meet or exceed the requirements of AAMA 2603, 2604 and 2605.

For additional information about the full line of quality products and services offered by YKK AP, call 1-800-955-9551 or visit our web site at www.ykkap.com.

YKK AP America



*Patterson Pump, Toccoa, Georgia
Architect: Design South
Glazing Contractor: Jemmings Paint & Glass, Inc.
Systems Used: YCW 750 OG & YCW 750 CV*

YCW 750 Concealed Vent

Maintains standard curtain wall sightline, visible only when in open position.

- Available configuration: Project Out
- AAMA/WDMA HC-60 rated
- Accepts 1" insulating glass
- YKK AP MegaTherm® thermal break
- Separate interior/exterior finish options
- Standard heavy-duty hardware

YES SSG Vent

Minimal sightline vent for use with storefront framing systems.

- Available configurations; Casement Outswing or Project Out
- AAMA/WDMA HC-60 rated
- Accepts 1" insulating glass
- Standard heavy-duty hardware
- Screens available

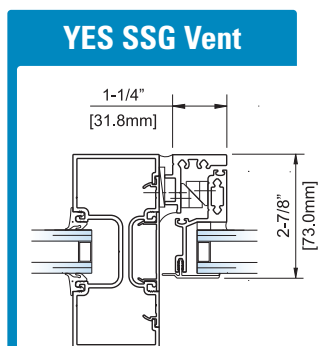

YSW 400 T

Architectural grade horizontal sliding window that offers ease of operation and is thermally broken.

- Available configurations: OX, XO, OXO, & XOX
- AAMA/WDMA AW-40 rated
- Accepts 1" insulating glass
- YKK AP MegaTherm® thermal break
- Standard heavy-duty hardware
- Factory glazing
- YVS 410 TU fixed lites available above, below, or next to sliding window
- Head/jamb receptors, & stacking mullions

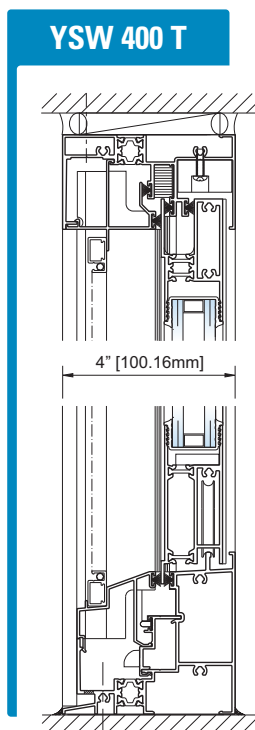

*New Palz Central High School, New Palz, New York
Architect: Collins & Scoville Architects, P.C.
Glazing Contractor: Forno Enterprises, Inc.
Systems Used: YES 45 FI, YES 45 TU, YSW 400 T & YVS 400 TU*

YOW 350 T

Thermally broken heavy duty operable window.

- Available configurations: Casement Outswing, Project Out, & Fixed
- AAMA/WDMA/CSA 101 I.S. 2/A 440-05
– AW-80 Operable, AW-100 Fixed
- MegaTherm® thermal break
- 3-1/2" frame depth
- Accepts 1" insulating glass
- Factory glazing & screens
- Head/jamb receptors & stacking mullions
- Standard heavy-duty hardware

YOW 225

High performance operable windows.

- Available configurations: Casement Outswing/Inswing, Project Out/In, & Fixed
- AAMA/WDMA: AW-60 Operable, AW-100 Fixed
- 2-1/4" frame depth
- Accepts 1/4" to 1" glazing
- Factory glazing & screens
- Head/jamb receptors & stacking mullions
- Standard heavy-duty hardware

YOW 225 TU

High performance thermally broken operable windows.

- Available configurations: Casement Outswing/Inswing, Project Out/In, & Fixed
- AAMA/WDMA: AW-65 Operable, AW-100 Fixed
- 2-1/4" frame depth
- ThermaBond Plus® thermal break
- Accepts 1/4" to 1" glazing
- Factory glazing & screens
- Head/jamb receptors & stacking mullions
- Standard heavy-duty hardware

YVS 400 TU Tilt-in YVS 410 TU Side Load

High performance, thermally broken single and double hung windows.

- AAMA/WDMA: YVS 400 TU – AW-50 Hung
YVS 410 TU – AW-65 Hung & AW-100 Fixed
- 4" frame depth
- ThermaBond Plus® thermal break
- Accepts 1/4" to 1" glazing
- Factory glazing & screens
- Full selection of block & tackle, spiral, and Class 5 Ultra-Lift balances
- SecurSweep sweep locks and SafSupport tilt support arms
- Full assortment of receptors, sill flashing, stacking mullions, panning, trim, & muntins

YOW 350 T

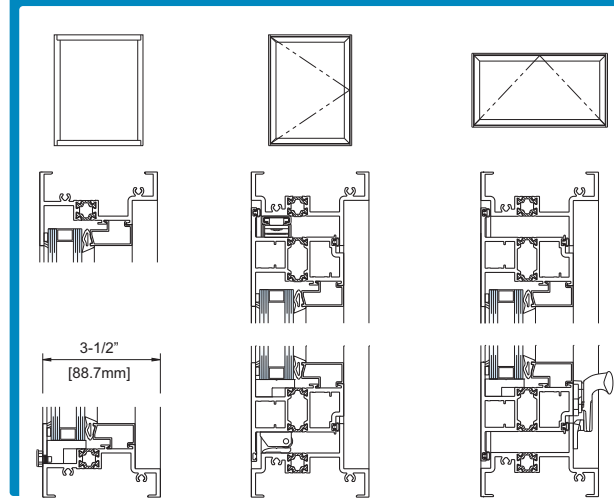

905 Juniper, Atlanta, Georgia

Architect: Cooper Carry

Glazing Contractor: Tuxedo Glass & Mirror, Inc.,

Systems Used: YCW 750 OG, YWW 50 T w/slab edge cover, YCW 750CV, YOW 225 TU, YSD 400 T, & Model 35D

YVS 400 TU

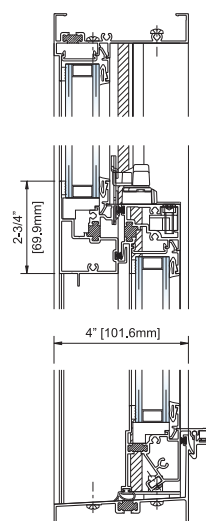

YVS 410 TU

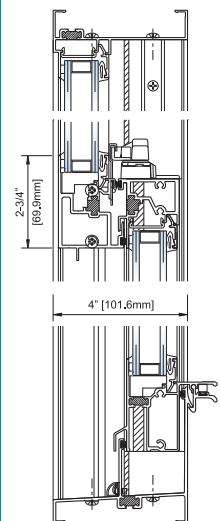

YKK AP America



Vista on The James, Richmond, Virginia
 Architect: Rule Joy Trammell Architecture
 Glazing Contractor: American Door & Glass
 Systems Used: YCW 750 OG, YWW 50 T w/ slab edge cover, YSD 400, & Model 50D

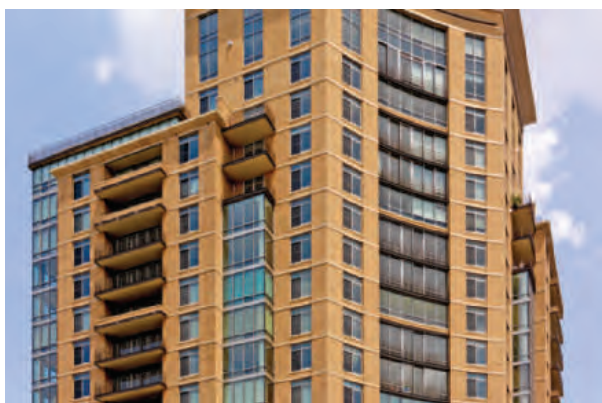

The Vue at Harbor East, Baltimore, Maryland
 Architect: Beatty, Harvey & Associates
 Glazing Contractor: Emmitsburg Glass
 Systems Used: YCW 750 OG, IG, YWE 60T, YCW 750CV, YES SSG Vent, YSW 400 T, YVS 410TU, YSD 600 T, & Model 50D

YSD 400

Heavy commercial grade sliding door that withstands higher structural loads without sacrificing aesthetics.

- Available configurations: OX, XO, XX, OXO, & OXXO
- AAMA/WDMA HC-60 Rated
- 4-1/16" frame depth
- Accepts 1" insulating glass
- Factory glazing & screens
- High sills & head/jamb receptors
- Standard heavy-duty hardware, including stainless steel tandem rollers & track cover for years of worry-free operation

YSD 600 T

Thermally broken architectural grade sliding door.

- Available configurations: OX, XO, OXO, & OXXO
- AAMA/WDMA AW-75
- 6" frame depth
- Accepts 1" or 1-3/16" insulating glass
- Factory glazing & screens
- Standard heavy-duty hardware, including stainless steel tandem rollers & track cover for years of worry-free operation

YSD 700

Heavy commercial sliding door.

- Available configurations: OX, XO, OXO, & OXXO
- AAMA/WDMA HC-120
- 7" frame depth
- Accepts monolithic or insulating glass
- Factory glazing (active panels) & screens
- Standard heavy-duty hardware, including stainless steel tandem rollers & track cover for years of worry-free operation

YTD 350 T

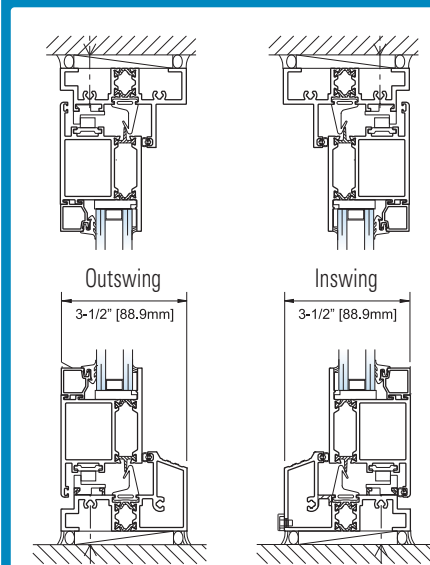

YTD 350 T

High performance, thermally broken architectural terrace swing door.

- 3-1/2" or 4-1/2" frame depth
- Available configurations: Outswing and Inswing
- YKK AP MegaTherm® thermal break
- AAMA/WDMA/CSA/101/I.S.2/A440-05
 - Outswing: ATD AW-80 single door, ATD AW-65 pair doors
 - Inswing: ATD AW-40 single and pair doors
- Doors shipped completely fabricated and mounted in frame to expedite installation
 - Single Doors: Up to 4'-0" x 8'-0" Frame Height
 - Pair Doors: Up to 8'-0" x 8'-0" Frame Height
- Factory glazing
- Fully adjustable hinges standard for proper alignment and weathertight seal
- Multi-point locking system for engages top and bottom rails in addition to the locking stile for added security

YKK AP ProTek™ Impact Resistant & Blast Mitigation Systems

IMPACT RESISTANT SYSTEMS

All YKK AP ProTek™ systems are engineered to create a protective envelope around your building – protecting it from fierce cyclical pressures and projectiles associated with hurricane force winds.

Contact YKK AP for glazing requirements.

SYSTEMS	IMPACT TESTED	
	Sm. Missile	Lg. Missile
WINDOWS		
YOW 225 H	YES	YES
YOW 225 TUH	YES	YES
YVS 410 TUH	YES	YES
SLIDING DOORS		
YSD 600 TH	YES	YES
YSD 700 H	YES	YES



All YKK AP ProTek™ window & sliding door systems are fully tested for Large & Small Missile Impacts compliant with South Florida Building Code Test Protocols TAS 201, TAS 203, and ASTM E 1886 & 1996.

YSD 600 TH

Thermally broken sliding door for high performance and hurricane impact applications.

- Available configurations: OX, XO, OXO, & OXXO
- AAMA/WDMA ±75 PSF
- Miami Dade NOA and Florida state-wide approval +100/-120 PSF
- 6" frame depth
- Accepts 1" or 1-3/16" insulating glass
- Factory glazing & screens
- Standard heavy-duty hardware, including stainless steel tandem rollers & track cover for years of worry-free operation



Southwind on the Ocean, Myrtle Beach, South Carolina
Architect: Pegram Associates
Glazing Contractor: Coastal Glass
Systems Used: YSD 600 TH

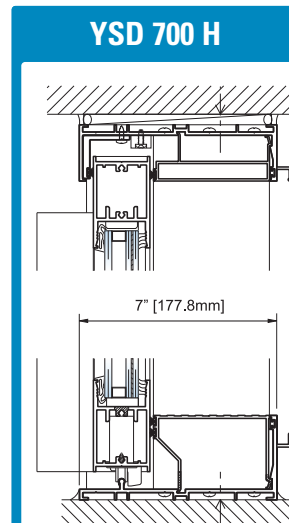
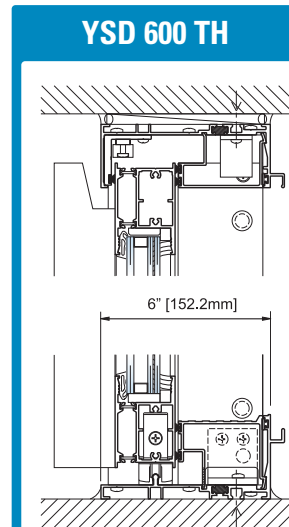

YSD 700 H

Heavy commercial sliding door for hurricane impact applications.

- Available configurations: OX, XO, OXO, & OXXO
- AAMA/WDMA HC-120
- Miami Dade NOA and Florida state-wide approval +100/-120 PSF
- 7" frame depth
- Accepts 9/16" monolithic, 1" or 1-3/16" insulating glass
- Factory glazing (active panels) & screens
- Standard heavy-duty hardware, including stainless steel tandem rollers & track cover for years of worry-free operation



Windows shown on this page were tested at 6psi/41psi-ms, resulting in the following performance ratings:

SYSTEMS ⁽¹⁾	Protection Levels		Comments
	ASTM F 1642 ⁽²⁾	GSA-TS01	
YOW 225 TUH			
Casement Out	Minimal Hazard	3b	6psi/41 psi-ms
Fixed/Project Out	Minimal Hazard	3b	6psi/41 psi-ms
YVS 410 TUH			
Single Hung	Minimal Hazard	3b	6psi/41 psi-ms

⁽¹⁾-Contact YKK AP for glazing requirements

⁽²⁾-Tested in accordance with ASTM F 1642 for compliance with UFC 4-010-01

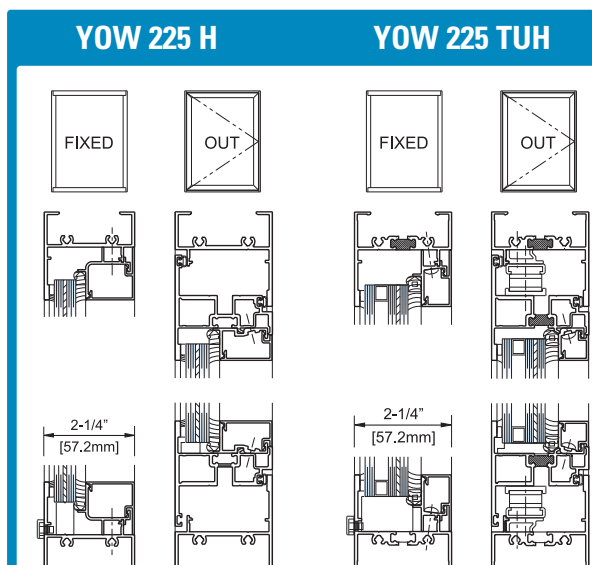

BLAST MITIGATION SYSTEMS

YKK AP has applied all the knowledge and experience that we gained in leading the development of hurricane impact resistant systems to providing protection for building occupants from man-made disasters. The majority of YKK AP ProTek™ systems meet the requirements of the Unified Facilities Criteria (UFC) and the requirements of the GSA. Several Systems have been fully tested in accordance with ASTM F-1642 to provide proven performance at higher loads without reinforcements

Contact YKK AP for glazing requirements.

YVS 410 TUH Side-load

| Thermally broken impact resistant single hung window.

- Available configurations: Single Hung, & Fixed
- AAMA/WDMA AW-65 (Hung) & AW-100 (Fixed) rated
- Miami Dade NOA and Florida state-wide approval +80/-120 PSF
- 4" frame depth
- ThermaBond Plus® thermal break
- Accepts 1" Large & Small Missile glazing
- Factory glazing and screens
- Block & Tackle, Spiral, and Class 5 Ultra-Lift® balances
- Blast Mitigation Testing

YOW 225 H

| Impact resistant operable window.

- Available configurations: Casement Outswing, Project Out, & Fixed
- AAMA/WDMA AW-65 Operable, AW-100 Fixed
- Miami Dade NOA and Florida state-wide approval +65/-65 PSF operable, +100/-100 PSF fixed
- 2-1/4" frame depth
- Accepts 9/16" glazing
- Factory glazing and screens
- Stacking mullions
- Standard heavy-duty hardware
- Blast Mitigation Testing

YOW 225 TUH

| Thermally broken impact resistant operable window.

- Available configurations: Casement Outswing, Project Out, & Fixed
- AAMA/WDMA AW-65 Operable, AW-100 Fixed
- Miami Dade NOA and Florida state-wide approval +65/-65 PSF operable, +100/-100 PSF fixed
- 2-1/4" frame depth
- ThermaBond Plus® thermal break
- Accepts 1-1/16" glazing
- Factory glazing and screens
- Stacking mullions
- Standard heavy-duty hardware
- Blast Mitigation Testing

Additional Information

Service Centers

Atlanta

5610 Gwaltney Drive
Atlanta, GA 30336
Tel: 404-629-3870
Fax: 404-629-3899

Boston

Eight Connector Road
Andover, MA 01810
Tel: 978-749-9554
Fax: 978-749-2915

Baltimore

8680 Greenwood Place
Savage, MD 20763
Tel: 301-498-3650
Fax: 301-498-3755

Chicago

1000 Stevenson Court
Suite 100
Roselle, IL 60172-4314
Tel: 630-582-9602
Fax: 866-955-2441

Cincinnati

5406 Spellmire Drive
Cincinnati, OH 45246
Tel: 513-942-7200
Fax: 513-682-2123

Dallas

2025 W. Belt Line Road
Suite 130
Carrollton, TX 75006
Tel: 972-245-9551
Fax: 972-245-9522

Greensboro

4524 Green Point Drive
Suite 106
Greensboro, NC 27410
Tel: 336-665-1963
Fax: 336-665-1965

Houston

3550 Brittmoore Road
Suite 200
Houston, TX. 77043
Tel: 713 329-9551
Fax: 713 939-0811

Orlando

7608 Currency Drive
Orlando, FL 32809
Tel: 407-856-0660
Fax: 407-856-0090

Headquarters

7680 The Bluffs
Suite 100
Austell, GA 30168
Tel: 678-838-6000
Fax: 678-838-6001

Download these brochures and more at www.ykkap.com



Hurricane Impact Resistant

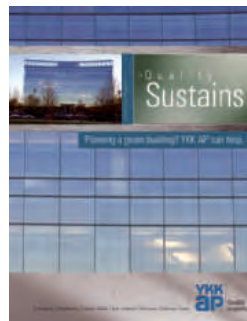

Environmental (LEED)



Blast Mitigation

For architectural specifications, details and warranty information, call 1-800-955-9551 or visit our website at www.ykkap.com.

The contents of this catalog are intended for product information only. All information and details within this catalog are subject to change without notice.

see us at
Sweets.com

©2008 YKK Corporation of America
16-1006-00

YKK AP America Inc.
7680 The Bluffs, Suite 100
Austell, GA 30168
1-800-955-9551
www.ykkap.com

YKK
ap Quality
inspires™