

**CENTRIA** is where building teams turn for metal wall and roof solutions and support. Our national and international sales and distribution networks will guide you from the design process to quality, on-time installation. Get the distinct advantage of CENTRIA's expertise through:

- ▶ Technical services at any phase of your project
- ▶ Sales service teams committed to total customer satisfaction
- ▶ Product selection and estimating
- ▶ Design and detailing assistance for standard and custom designs
- ▶ Development of specifications
- ▶ Consulting on substrates, coatings and colors
- ▶ Comprehensive in-house coil coating services
- ▶ Thermal and structural analysis



**CENTRIA**

Architectural Metal Wall Systems

1005 Beaver Grade Road  
Moon Township, PA 15108-2944  
800.759.7474

**CENTRIA.com**

Reference PS 4/09 10M PG/GCS  
Copyright ©2009 CENTRIA



**CENTRIA**

**PROFILE** Series

Architectural Metal Wall Systems



# AESTHETICS

The broad selection of the Profile Series system provides thousands of textures, shadows and sight lines, along with a complete line of design, finish, integration, special systems and detail options.

CENTRIA PROFILE Series offers a full metal palette of both concealed and exposed fastener panels with the design flexibility of no other single-skin, profiled metal wall system.

## AESTHETICS | PERFORMANCE | SUSTAINABILITY

CENTRIA is the place where owner and architect visions are realized, contractor challenges are conquered and discoveries are made for greener ways to build with metal. As with all CENTRIA products, the Profile Series systems are engineered to exceed expectations through our commitment to help create buildings that are beautiful, functional and sustainable.

*Front Cover*  
Indiana Forensic and Health Sciences Laboratories  
Indianapolis, IN



North Memorial Medical Office  
Building – Maple Grove, MN

“Art is the imposing of a pattern on experience, and our aesthetic enjoyment is recognition of the pattern.”

— Alfred North Whitehead

British Mathematician and Philosopher, 1861-1947



Matae Belltown Condominiums  
Seattle, WA

## DESCRIPTION

- ▶ Galvanized steel – standard
- ▶ Galvalume® steel, stainless steel or aluminum – optional
- ▶ Smooth or embossed surface texture
- ▶ Horizontal or vertical installation
- ▶ Lengths up to 30' [9.15m]

CENTRIA Concept Series concealed fastener wall panels are variations on a single theme — an asymmetrical rib shape. From this dynamic form are derived a series of six distinct panel profiles that can be installed interchangeably, either vertically or horizontally, creating unlimited new custom metal wall designs.



Pickleweed Community Center and Library  
San Rafael, CA



BiRite Food Distribution Service  
Brisbane, CA

Concept Series concealed fastener panels feature increased panel engagement for a tighter joint that's virtually invisible. A unique, concealed fastening clip design allows unimpeded thermal movement and creates an air cavity without shims or subgirts, between the backside of the panel and the weather resistive barrier — a critical feature for effective moisture control in rainscreen design.

For vertical, soffit, or other applications where thermal movement is less critical, Concept Series panels may be ordered with optional concealed extended fastener legs.

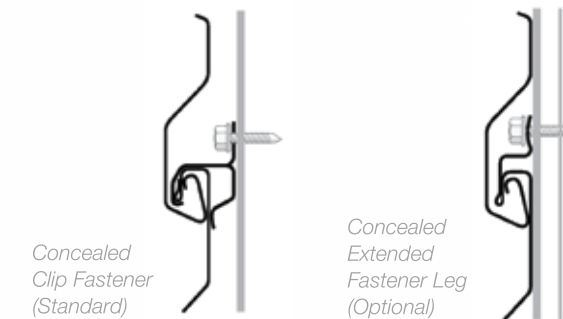

## AESTHETIC OPTIONS

Concept Series opens the door to unprecedented design flexibility in preformed panels. The six asymmetrical profiles, each with identical vented, rainscreen and pressure-equalized joinery, can be interchanged for aesthetic brilliance of your design.

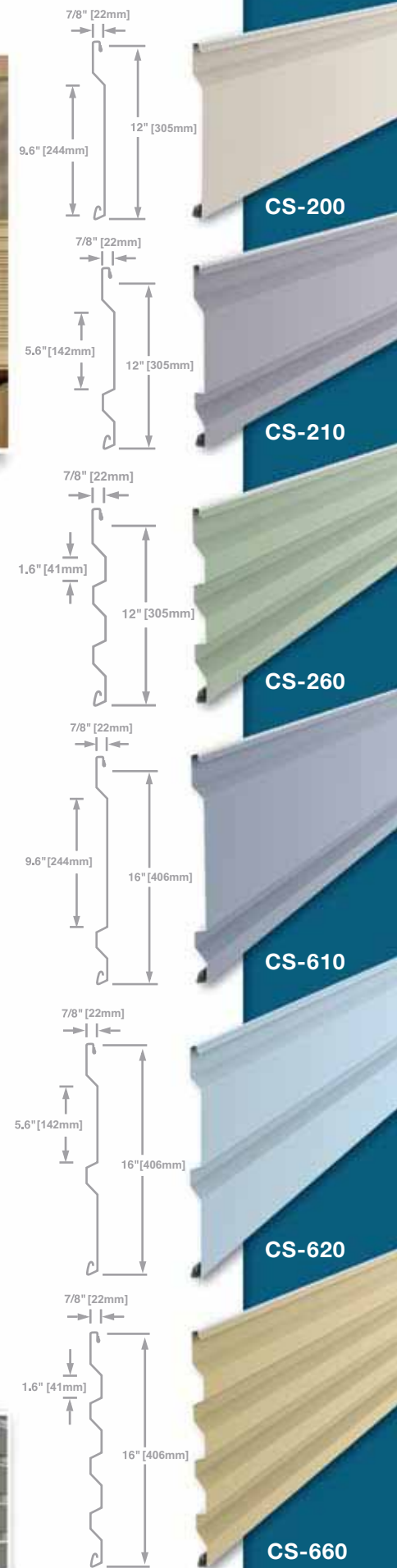



Medrad Global Center  
Warrendale, PA

## DESCRIPTION

- ▶ Galvanized steel – standard
- ▶ Galvalume® steel, stainless steel or aluminum – optional
- ▶ Smooth or embossed surface texture
- ▶ Horizontal or vertical installation
- ▶ Lengths up to 30' [9.15m]
- ▶ 2" [51mm] swaged laps are available in gages lighter than 18 for most shapes

CENTRIA IW Series concealed fastener wall panels provide a clean, monolithic appearance to architectural design. The interchangeable weather-resistant lock-joint design of IW-10A through IW-41A allows you to mix and match panel profiles throughout your design. IW Series panels may be installed either vertically or horizontally.



## AESTHETIC OPTIONS

IW Concealed Fastener Panels offer many options (designs IW-10A through IW-60A, to be exact) for interesting visual effects. Stucco-embossed or smooth finishes in flush, vertically ribbed, striated, and stepped profiles help designers achieve reveals and shadows, visual textures, and other distinctive architectural effects.



North Carolina Center for the Arts  
Winston-Salem, NC



Perspectives Charter School  
Chicago, IL



Little Elm Athletic Complex  
Little Elm, TX



Walgreens Distribution Center  
Williamston, SC

## DESCRIPTION

- ▶ Galvanized steel – standard
- ▶ Galvalume® steel, stainless steel or aluminum – optional
- ▶ Smooth or embossed surface texture
- ▶ Horizontal or vertical installation
- ▶ Lengths up to 40' [12.19m]

CENTRIA's field assembled exposed fastener panel systems are the most versatile and widely utilized metal panel systems for wall and roof applications. They are used on virtually every type of structure, from mills and warehouses to schools and office buildings.

Like all CENTRIA Profile Series Panels, the Exposed Fastener Panels may be used with a variety of insulated or non-insulated back-up systems in a wide range of designs and colors.

## AESTHETIC OPTIONS

From the wavy corrugations of Econolap 1/2" to the bold articulations of Super-Rib, exposed fastener wall and roof panels are CENTRIA's most versatile and popular profiles. These panels can be installed vertically or horizontally, curved to extreme degrees, or used to create roofs, liners and even soffits.



Target Midtown  
Atlanta, GA



Norfolk Cruise Terminal  
Norfolk, VA

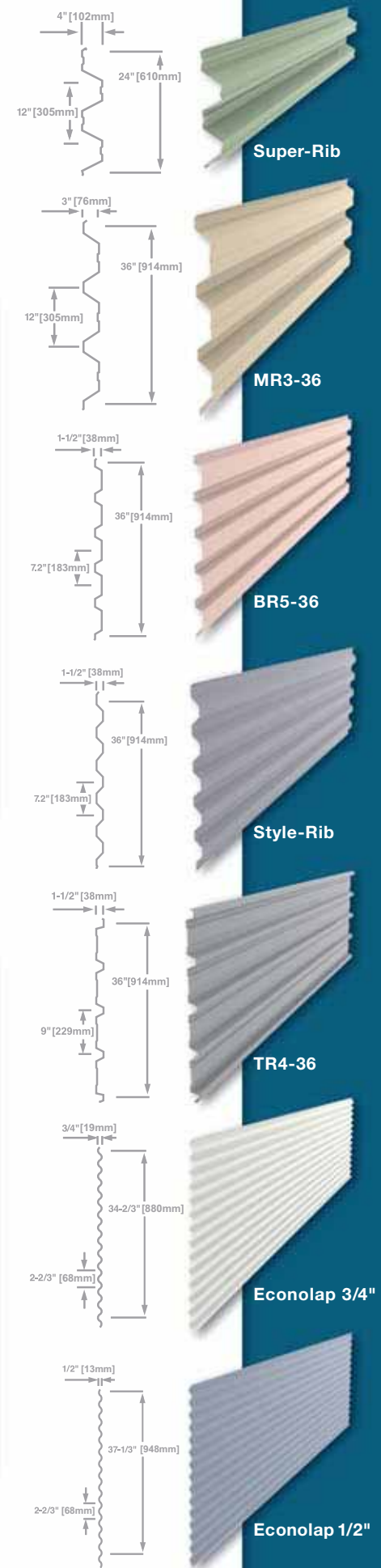



Charlotte Douglas Airport – Parking Deck  
Charlotte, NC

## DESCRIPTION

- ▶ 20 [.91mm] gage stainless steel or 0.040 [1mm] painted aluminum
- ▶ Available in Econolap 3/4", Style-Rib, MR3-36, BR5-36, CS-260 and CS-660
- ▶ Hole diameters and spacings vary
- ▶ 10% - 40% free area

CENTRIA created EcoScreen Perforated Screenwalls for a unique and attractive way to shield industrial and operational equipment while integrating with the surrounding building structures. EcoScreen, made with stainless steel and 100% renewable energy, earned the first ever Cradle-to-Cradle™ Gold Certification for exterior building products.



## AESTHETIC OPTIONS

The unique fabrication of EcoScreen panels provides 10% to 40% open area for the effect of a translucent screen to control light, provide air movement and security, and conceal objects behind the screen. Architects frequently use screenwall panels for striking visual effects in stairwells, parking garages, stadium design, and commercial signage.



University of Pennsylvania Chilled Water Plant  
Philadelphia, PA



International Trade Center Parking Deck  
Charlotte, NC

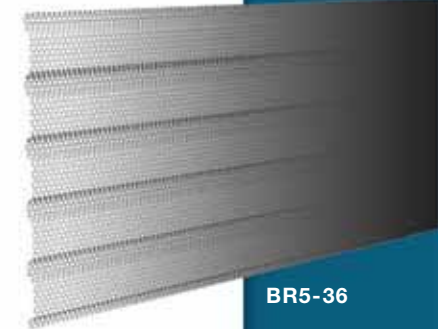

BR5-36

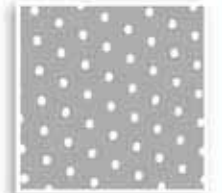

10% Open Area  
Reverse Pattern  
1/8" Diameter  
3/8" Spacing

*Standard*

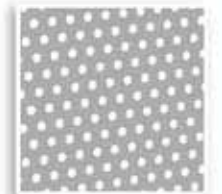

23% Open Area  
Staggered Pattern  
1/8" Diameter  
1/4" Spacing

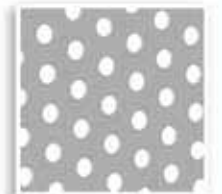

23% Open Area  
Reverse Pattern  
1/4" Diameter  
1/2" Spacing

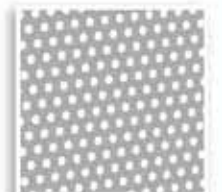

30% Open Area  
Staggered Pattern  
1/8" Diameter  
7/32" Spacing

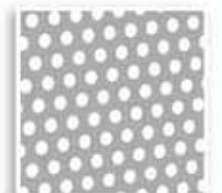

33% Open Area  
Staggered Pattern  
3/16" Diameter  
5/16" Spacing

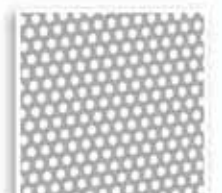

40% Open Area  
Staggered Pattern  
1/8" Diameter  
3/16" Spacing

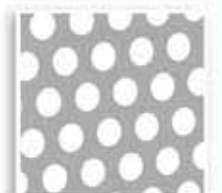

40% Open Area  
Staggered Pattern  
3/8" Diameter  
9/16" Spacing

*Standard*



Cal Train Maintenance and Operations Facility  
San Jose, CA

## DESCRIPTION

- ▶ Painted galvanized steel – standard
- ▶ Painted aluminum – optional
- ▶ Same material and finish as adjacent panels
- ▶ 2' [610mm] x 2' x 90° outside corners – standard
- ▶ Inside corners, variable angles with leg lengths from 12" to 42" [305mm to 1.07m] 15" [381mm] for Concept Series

CENTRIA MicroSeam Corners use cutting edge structural bonding techniques to produce corners that appear virtually seamless. Manufactured from the same substrate coil as the panels, MicroSeam Corners eliminate riveting, welding and post-painting, creating the cleanest corner transitions ever.

## AESTHETIC OPTIONS

Clean, sharp MicroSeam corners give designs unparalleled smoothness and are available in CENTRIA's full palette of nearly 100 colors, including metallics. Available as both inside and outside corners, MicroSeam corners provide a crisp, seamless transition appearance.



Matae Belltown Condominiums  
Seattle, WA



Carl Sandberg High School  
Orland Park, IL



Bradford Middle School  
West Port, CT

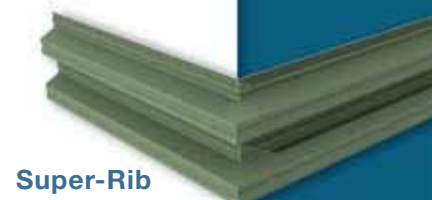

Super-Rib

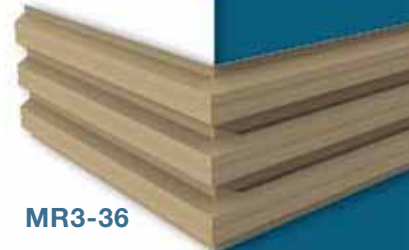

MR3-36

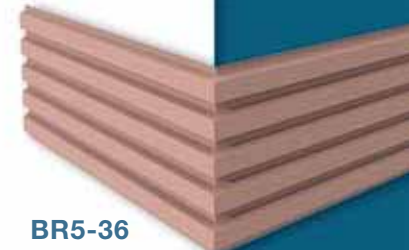

BR5-36

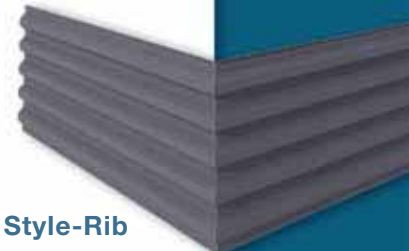

Style-Rib

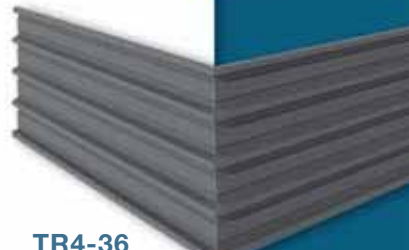

TR4-36

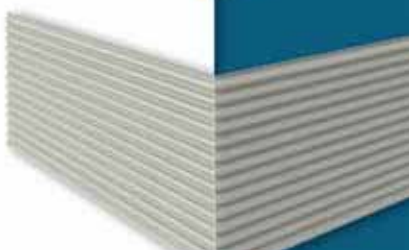

Econolap 3/4"



Concept Series  
& IW Series



California State University, Stanislaus  
Naraghi Hall of Science – Turlock, CA

## DESCRIPTION

- ▶ Lengths up to 16' [4.88m]
- ▶ Finished to either match or contrast wall panels
- ▶ Refer to page 25 for availability

MicroLine details incorporate aluminum extrusions designed to integrate visually and mechanically with CENTRIA Profile Panels. Slim 2" [51mm] wide CENTRIA MicroLine Extrusions make it a snap to trim and finish around windows and doors, inside or outside corners, and at the base of walls — or to create clean vertical joints.

## AESTHETIC OPTIONS

MicroLine Extrusions enable you to replace wide obtrusive flashing and exposed fasteners with narrower, crisper and cleaner finished lines. The flexibility of these details allow you to match or complement wall panels.



X-Rite Corporate Headquarters  
Grand Rapids, MI



Washington Twp. Elementary School  
Bangor, PA



Vertical Joint



Inside Corner

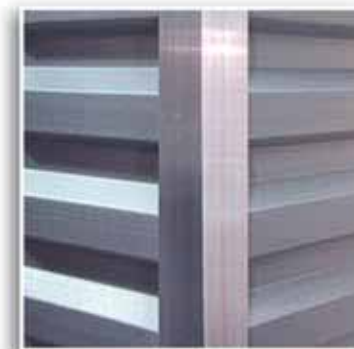

Outside Corner



Endwall

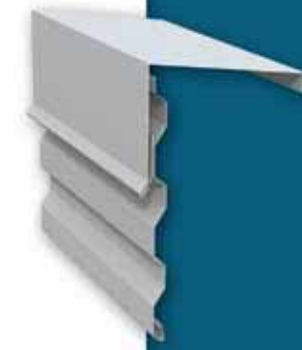

Coping\*



Head Opening



Sill Opening



Base

\*Coping illustrated is the same flashing material as the panel.



# Curved Architectural Panels



Countryside Elementary School  
Bryon Center, MI

## DESCRIPTION

### Crimp curved profiles

- ▶ Style-Rib, Super-Rib, BR5-36, MR3-36 and TR4-36
- ▶ Galvanized steel – standard, aluminum – optional
- ▶ Radii as tight as 2'-0" [610mm]
- ▶ Lengths up to 30' [9.14m]

### Smooth curved profiles

- ▶ Econolap 3/4"
- ▶ Galvanized steel – standard, aluminum – optional
- ▶ Radii as tight as 5'-0" [1.52m]
- ▶ Lengths up to 15' [4.57m]

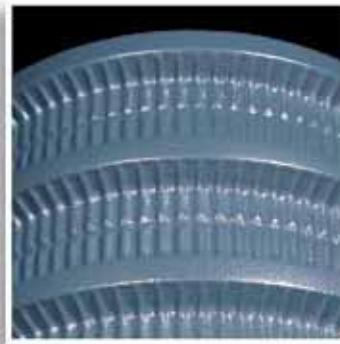

Crimp Curve

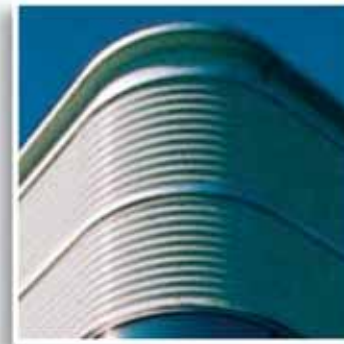

Smooth Curve

Add curved design elements to your project with CENTRIA Curved Architectural Panels. Available in a wide selection of exposed fastener profiles, finishes and colors to match virtually any architectural, commercial or industrial application. Curved Architectural Panels are ideal for walls, roofs, canopies, awnings, fascia, parapets, column and beam wraps, mansards, miters and bullnoses — even custom shapes.

# PROFILE Louvers



Ralph Wright Natatorium  
Louisville, KY

## DESCRIPTION

- ▶ Available in Super-Rib, MR3-36, Style-Rib, BR5-36, IBR5-36, CS-260 and CS-660
- ▶ Same material and finish as adjacent panels
- ▶ Blade lengths up to 15' [4.57m]
- ▶ Variable blade depths from 1-1/2" to 8" [38mm to 203mm]
- ▶ Free areas from 10% to 49%

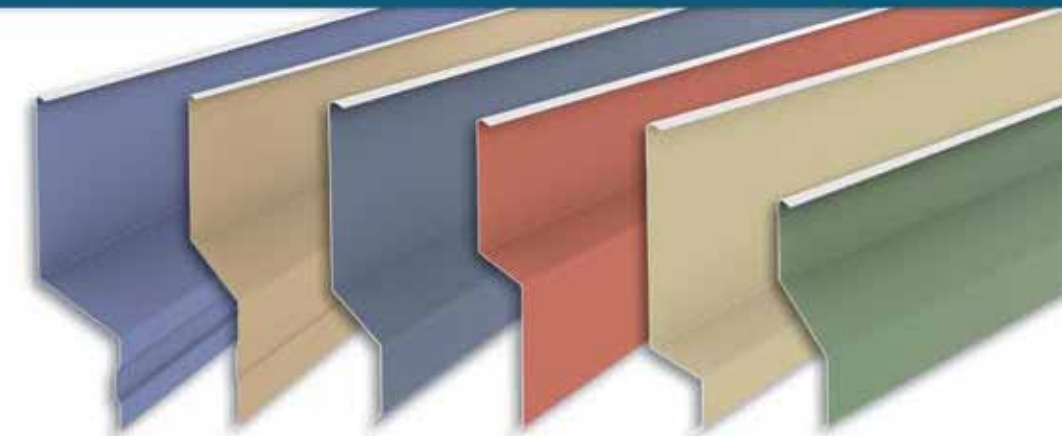

Super-Rib MR3-36 Style-Rib BR5-36 IBR5-36 CS-260 & CS-660

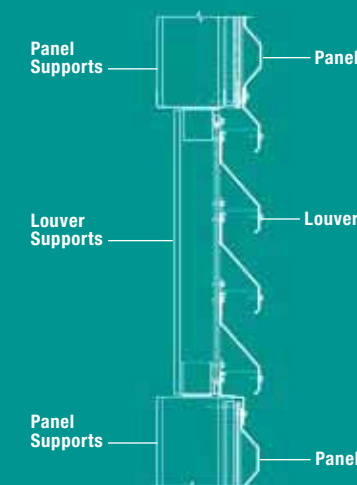

With CENTRIA Profile Louvers, you can now blend louvers invisibly into your design. Profile Louvers match adjacent Profile Panels in material and finish, and come in a wide variety of blade depths and spans to create free area from 10% to 49% for air intake or exhaust.

# PERFORMANCE

Profile Series panels are an excellent choice for both new and retrofit applications and integrate well with other building materials. Their all-weather installation capability permits fast-track installation scheduling.

Advanced Thermal  
and Moisture Protection®



Harrah's Casino  
Chester, PA

## OPAQUE WALL THERMAL REQUIREMENTS FOR STEEL FRAMED WALLS AS STATED IN THE ASHRAE/IESNA STANDARD 90.1

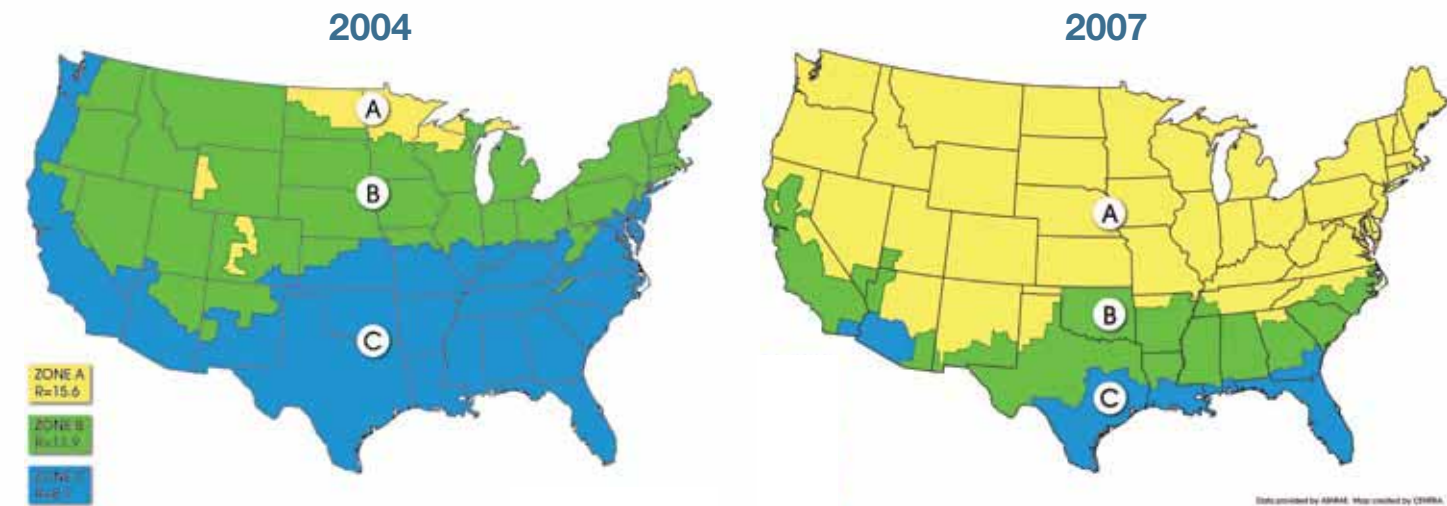

### System tests per ASTM C236 for various insulation systems

CENTRIA Insulating Systems	Effective R-Value	Typical Multi-Component Wall Systems	Effective R-Value
L2 Liner with 2" 1.65 PCF Insulation	R- 9.07	4" Studs @ 16" O.C. with 4" .6 PCF Insulation	R- 6.4
L2-2 Liner with 3" 1.65 PCF Insulation	R-13.12	4" Studs @ 24" O.C. with 4" .6 PCF Insulation	R- 7.8
L2-2 Liner with 3"+1½" 1.65 PCF Insulation	R-17.99	6" Studs @ 16" O.C. with 6" .6 PCF Insulation	R- 7.4
MetalWrap 2" Wall assembly	R-14	6" Studs @ 24" O.C. with 6" .6 PCF Insulation	R- 9.0
MetalWrap 3" Wall assembly	R- 21		

CENTRIA's ATMP® – Advanced Thermal and Moisture Protection Technology is one example of the steps we have taken to improve performance in our products. Products like MetalWrap™ maximize a wall system's ability to effectively control moisture without sacrificing thermal efficiency.

"Buildings should serve people, not the other way around."

— John Portman

Architect & developer known for the creation of the multi-storied atrium hotel.



## DESCRIPTION

- ▶ Thickness – 2" [51mm] or 3" [76mm]
- ▶ Thermal – 2" [51mm] – R-14 Assembly or 3" [76mm] – R-21 Assembly
- ▶ Width – 36" [914mm]
- ▶ Length – 12' [3.66m] or 20' [6.10m] standard lengths
- ▶ Face and Liner – 29GA, AZ-50 Galvalume Plus
- ▶ Foam Insulation – Minimum 2.4 PCF Urethane modified isocyanurate foam
- ▶ Vertical or Horizontal installation for cladding panels
- ▶ Available for CENTRIA Concept Series®, IW Series, Exposed Fastener and FormaBond® exterior cladding panels

MetalWrap™ is an alternative thermal, air and moisture backup panel system designed specifically for CENTRIA non-insulated metal wall systems. MetalWrap brings unique design, superior energy efficiency and high performance to metal wall backup systems. The integrated single-panel design technology eliminates the need for conventional batt or board installation, exterior gypsum board, air barriers, vapor retarders and building wraps.

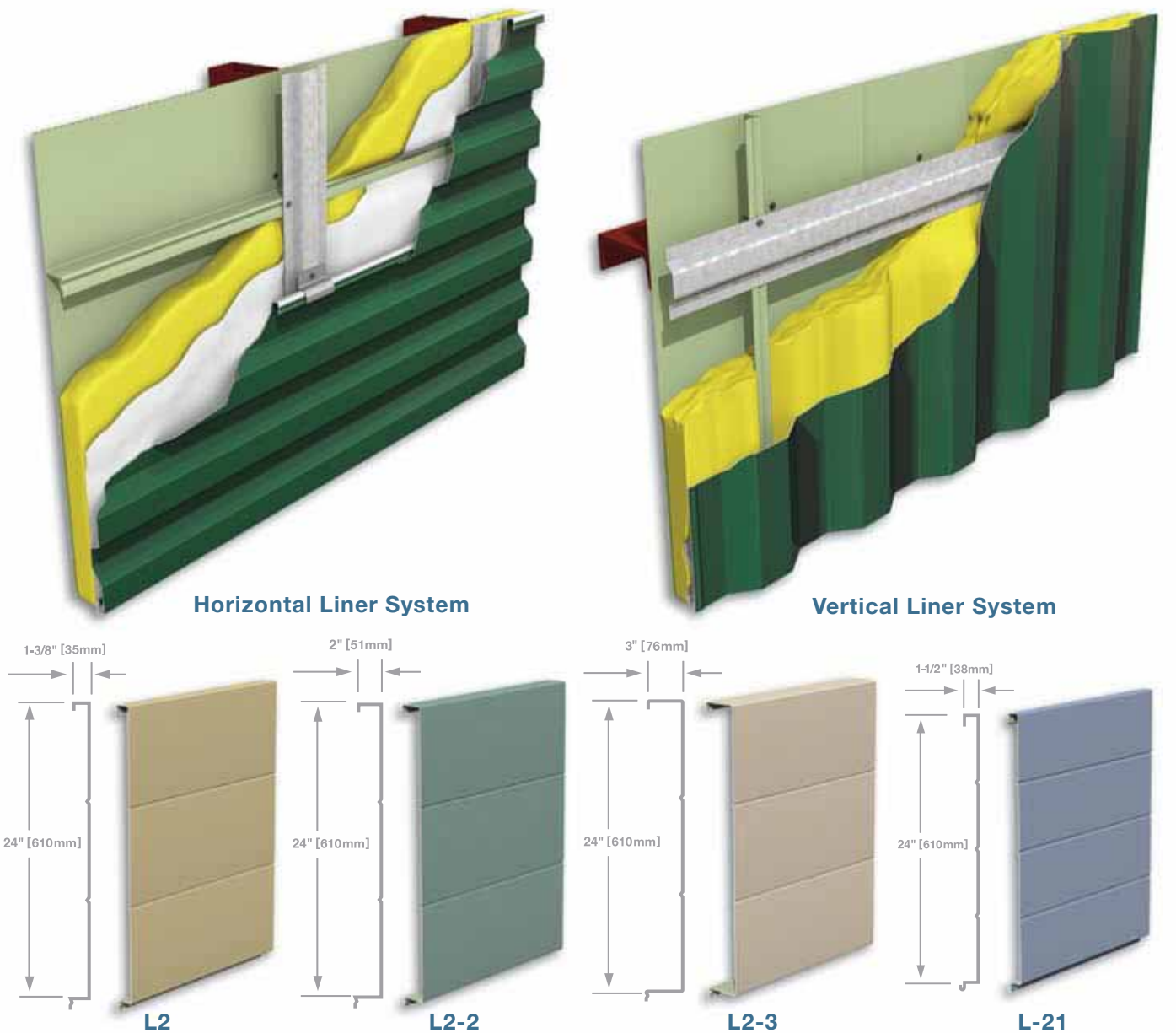

## DESCRIPTION

- ▶ Galvanized steel
- ▶ Subgirts available in "Zee" or "Hat" shapes
- ▶ Provides interiors a flush appearance
- ▶ Can accommodate a variety of thicknesses of fiberglass insulation

Behind our walls is another important benefit. To achieve higher insulation values while creating an attractive building interior, all CENTRIA profile walls can be combined with insulation and steel liner panels. These liner panels come in widths of 24" [610mm] and lengths up to 30' [9.14m], and are available in any CENTRIA color or finish.

# FIREWALL SYSTEMS

With the CENTRIA Firewall System, layers of fire resistant gypsum board are included between the exterior profile panel and the insulation and liner panel. By increasing the number of layers of gypsum board, CENTRIA provides UL one-hour to four-hour firewalls based on ASTM E119 fire tests. All CENTRIA Profile panels can be used in a Firewall system.

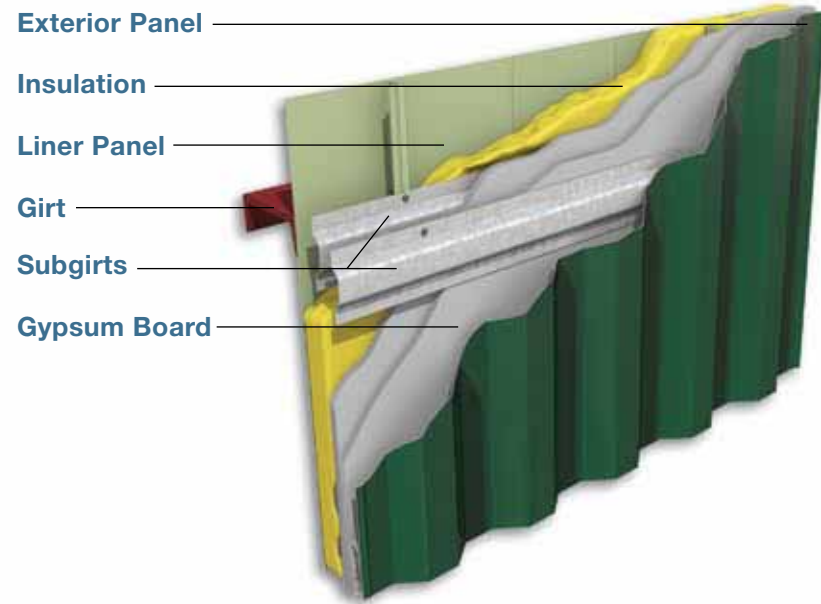

# QUIETWALL® SYSTEMS

Noise pollution issues are at the forefront of industrial design. For over 25 years, CENTRIA has been addressing these challenges through extensive experimentation and testing to perfect the acoustic performance of its Profile Series wall systems. The result is the CENTRIA Quietwall system that helps you specify a CENTRIA profile wall system with the specific sound absorption or sound transmission loss values your design requires.

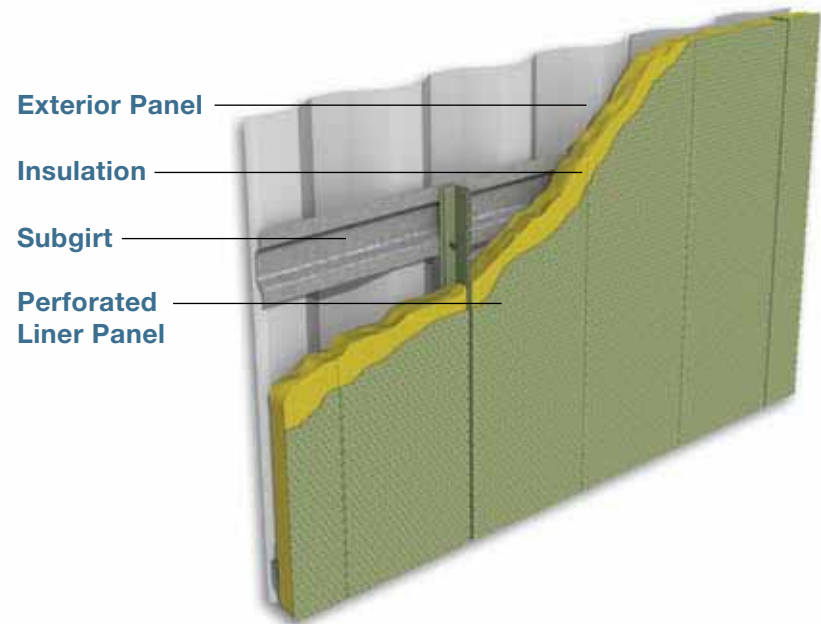

## Other Systems

CENTRIA's Explosion Release System, utilizing pressure venting washers, is designed for structures subject to possible explosive pressures from within.

CENTRIA also provides radio frequency shielding solutions to meet your RF shielding requirements.

# COATING SYSTEMS

## DESCRIPTION

CENTRIA has devoted more than 100 years to the art and science of producing metal walls and roofs that impart the very best in aesthetics and performance. This includes a wide variety of high-quality coating systems, a full palette of colors and a range of substrates and surface textures to meet even the most demanding environmental conditions.

## Available Substrates

- ▶ Standard G-90 hot-dip galvanized steel conforming to ASTM 653
- ▶ Galvalume\* steel, hot-dip coated with aluminum-zinc alloy conforming to ASTM A792 for heat and corrosion resistance
- ▶ Stainless Steel\*\*, Type 304 AISI architectural grade alloy; austenitic, non-magnetic, non-glare surface; slight variation in surface finish
- ▶ Aluminum Standard Alloy 3003-H14 and for standing seam roof panels, 3004-H34, available in smooth surface as a substrate

NOTE: Galvalume, stainless and aluminum may not be available for all product profiles or coating systems. Consult CENTRIA sales.

\*Polyvinylidene Fluoride (PVDF) coat contains 70% Kynar 500 or Hylar 5000 resin. Kynar 500 is a Reg. TM of Atofina Chemicals, Inc. Hylar 5000 is a Reg. TM of Solvay Solvents, Inc. Galvalume is a Reg. TM of BIEC International, Inc. \*\*Subject to minimum quantity requirements

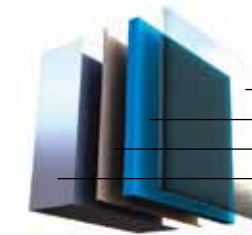

## SUNDANCE AM-ALUMINIUM METALLIC 3-COAT FINISH

A quality, durable coating providing the iridescence and reflectivity of a metallic surface.

- .5 mil [13 micron] nominal Polyvinylidene Fluoride Clear Coat\*
- .8 mil [20 micron] nominal Polyvinylidene Fluoride Color Coat\*
- .2 mil [5 micron] nominal Primer
- Substrate

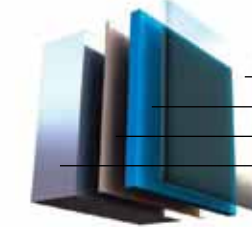

## DURAGARD® PLUS

A premium, high build architectural coating providing the ultimate in color retention and fade resistance.

- .8 mil [20 micron] nominal Polyvinylidene Fluoride Clear Coat\*
- .8 mil [20 micron] nominal Polyvinylidene Fluoride Color Coat\*
- .8 mil [20 micron] nominal Primer
- Substrate

## DURAGARD®

- .8 mil [20 micron] nominal Polyvinylidene Fluoride Color Coat\*
- .8 mil [20 micron] nominal Primer

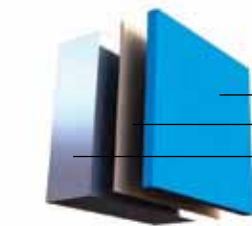

## FLUOROFINISH®\* AND SUNDANCE MICA

A Kynar 500®, Hylar 5000® or FEVE-based coating providing good durability.

- .8 mil [20 micron] nominal Color Coat
- .2 mil [5 micron] nominal Primer
- Substrate

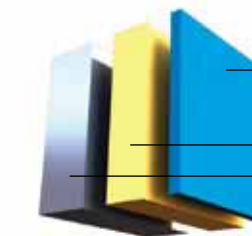

## VERSACOR® ULTRA PF, TF and HF

A premium, high build, multi-layer coating for applications where corrosion and abrasion resistance is more important.

- PF - 0.8 mil [20 micron] nominal PVDF Coat
- TF - 1.5 mil [38 micron] nominal Urethane Coat
- HF - 3.0 mil [75 micron] nominal Urethane Coat
- 3.0 mil [75 micron] nominal Versacor Ultra Barrier Coat
- Substrate

## The Industry's Widest Array of Colors

CENTRIA offers you a full array of colors from our COLORSTORM™ palette (see CENTRIA Colorstorm™ brochure) including micas and bright metallics.

## Custom Color Matching

CENTRIA is also equipped with the latest color matching technology enabling us to provide fast turnaround on even the most unique colors. For complete information on CENTRIA coating systems, contact us for a copy of our Coatings Brochure.

"Oil canning" is an inherent part of light gage cold-formed metal products, particularly those with broad flat areas. CENTRIA takes every precaution, as defined by MCA, to minimize the effects of oil canning. Lack of flatness or waviness due to oil canning is not sufficient cause for rejection of material.

# SUSTAINABILITY

Beyond the long-term weather resistant performance Profile Series panels are known for, they also provide excellent thermal efficiency when combined with insulation and a liner panel. As with all CENTRIA products, Profile Series panels have inherent sustainable characteristics. Our products are primarily composed of steel and other metals which have been, and can repeatedly be, recycled.



Upper Landing Condominiums  
St. Paul, MN

"The good building is not one that hurts the landscape, but one which makes the landscape more beautiful than it was before the building was built."

— Frank Lloyd Wright

Architect

## EcoCENTRIA



CENTRIA continues to lead the industry with new and innovative products to lighten our footprint on the earth. As the first to offer Cradle-to-Cradle™ building envelope products, our pursuit of excellence and improvement in the design, engineering and manufacturing of exterior wall and roof systems always keep sustainability top of mind. It's one thing to offer eco-friendly products — at CENTRIA we offer eco-friendly, recyclable products that also incorporate aesthetics, performance and durability.



As a member of USGBC, CENTRIA is committed to helping architects and owners achieve LEED® credit for using CENTRIA products. By choosing to use CENTRIA products, we can help you achieve the following LEED-NC credits:

CENTRIA LEED-NC 2009 Credit Categories	PRODUCT NAME					
	Concept Series	IW Series	Exposed Fastener	EcoScreen Perforated Screenwall	MetalWrap™	Standing Seam Roof
<b>ENERGY &amp; ATMOSPHERE POINTS</b>						
EA Credit 1: Optimize Energy Performance					1-19 Points	
EA Credit 2: On-Site Renewable Energy						1-7 Points
<b>MATERIALS &amp; RESOURCES</b>						
MR Credit 4.1: Recycled Content 10%	1 Point	1 Point	1 Point	1 Point	1 Point	1 Point
MR Credit 4.2: Recycled Content 20%	1 Point	1 Point	1 Point	1 Point	1 Point	1 Point
<b>INDOOR ENVIRONMENTAL QUALITY</b>						
EQ Credit 4.1: Low-Emitting Materials: Adhesives and Sealants	1 Point	1 Point	1 Point	1 Point	1 Point	1 Point
EQ Credit 4.2: Low-Emitting Materials: Paints and Coatings	1 Point	1 Point	1 Point	1 Point	1 Point	1 Point
<b>INNOVATION AND DESIGN PROCESS*</b>						
ID Credit 1.X: Innovation in Design: Cradle-to-Cradle Certification	1 Point	1 Point	1 Point	1 Point	1 Point	1 Point
<b>Sustainable Sites</b>						
SS Credit 7.2: Heat Island Effect: Roof			1 Point			1 Point

\*In order to utilize the tiered rating system of the Cradle-to-Cradle™ Certification program:

- ▶ Silver Certification Level is valued at ½ the cost value of products
- ▶ Gold Certification Level is valued at the equivalent cost value of products
- ▶ Platinum Certification Level is valued at 2X the cost value of the products

### OUR VISION STATEMENT

CENTRIA will meet the sustainability needs of customers by developing environmentally friendly products, reducing our consumption of water, energy and harmful chemicals and continuing on our path of social responsibility.



CENTRIA takes an active role in making a difference in the building and construction industry. As a sustainability leader, we are committed to social responsibility and environmental stewardship in all we do.

## CONSTRUCTION WASTE MANAGEMENT

- ▶ CENTRIA products are engineered and detailed for each building to minimize jobsite waste.
- ▶ Where applicable, conventional wood and waterproof paper packaging have been replaced with recyclable shrink wrap.
- ▶ ATMP Technology minimizes the number of materials required to build a complete wall system, reducing the number of trucks required for shipping and eliminating packaging waste.

## RECYCLING



- ▶ Repurposed remnant steel coils are used as subgirts and packaging.
- ▶ Unused paint is reformulated for alternate use.

## CRADLE-TO-CRADLE



The Cradle-to-Cradle<sup>SM</sup> certification process, administered by McDonough Braungart Design Chemistry (MBDC), evaluates a material or product's ingredients — and the complete formulation for human and environmental health impact throughout its life cycle — as well as its potential for being truly recycled or safely composted.

Cradle-to-Cradle evaluation demands a steadfast commitment to continuous improvement. Lasting only one year, each certification must undergo an annual review with specific attention being given to enhancement in protocols and practices.

CENTRIA is proud to utilize Advanced Thermal and Moisture Protection (ATMP) technology into many of our products including MetalWrap<sup>™</sup>, the latest in the Profile Series. Innovative ATMP solutions involve insulated metal composite panels that are installed outboard of a building's metal studs. ATMP has become an energy conservation solution in construction, providing the improved thermal efficiency required by many city, state and national codes.



PRODUCTS	CATEGORIES									
	Roof Options	Horizontal Installation	MicroSeam Corners	MicroLine Extrusions	Curved Option	Louvers	Swaged Laps	EcoScreen	Quietwall	Firewall
<b>CONCEPT SERIES</b>										
CS-200		X	X	X					X	X
CS-210		X	X	X					X	X
CS-260		X	X	X		X		X	X	X
CS-610		X	X	X					X	X
CS-620		X	X	X					X	X
CS-660		X	X	X		X		X	X	X
CS-200E		X	X	X					X	X
CS-210E		X	X	X					X	X
CS-260E		X	X	X					X	X
CS-610E		X	X	X					X	X
CS-620E		X	X	X					X	X
CS-660E		X	X	X					X	X
<b>IW SERIES</b>										
IW-10A		X	X	X*			X		X	X
IW-11A		X	X	X*			X		X	X
IW-12A		X	X	X*					X	X
IW-13A		X	X	X*		X			X	X
IW-14A		X	X	X*					X	X
IW-15A		X	X	X*					X	X
IW-20A		X	X	X*			X		X	X
IW-21A		X	X	X*			X		X	X
IW-30A		X	X	X*			X		X	X
IW-31A		X	X	X*			X		X	X
IW-40A		X	X	X*			X		X	X
IW-41A		X	X	X*			X		X	X
IW-60A		X	X	X*					X	X
<b>EXPOSED FASTENER PANELS</b>										
Super-Rib	X	X	X		X	X			X	X
MR3-36	X	X	X		X	X		X	X	X
BR5-36	X	X	X	X*	X	X		X	X	X
Style-Rib	X	X	X	X*	X	X		X	X	X
TR4-36	X	X	X	X*	X				X	X
Econolap 3/4"	X	X	X	X*	X			X	X	X
Econolap 1/2"	X	X							X	X
<b>LINER PANELS</b>										
L2		X							X	X
L2-2		X							X	X
L2-3		X							X	X
L-21		X							X	X

\*Horizontal applications only