



Real Security Sets You Free.™

08 71 00/ING

BuyLine 4081

Residential Locksets

2008 Architectural Guide



Real security is knowing you've made the right choice.

When it comes to security and safety, no other name is trusted like Schlage. For more than 85 years Schlage has been developing tough, innovative and beautiful security products. We have one of the world's largest team of hardware and electronic specification writers to support you and your clients. And because we're the brand your clients know and trust, they'll trust your choice too.

Residential Door Hardware

We've taken our experience in commercial door hardware and applied it to developing some of the toughest, most advanced door hardware for residential applications. From innovative electronic keypad locks to elegant high security handlesets, interior levers, knobs and decorative hardware, our residential products deliver reliable security and a wide variety of styles and finishes to complement any home design.



Schlage Residential products include:

- BE/FE Series
- F/FA Series
- Dexter by Schlage Builders Hardware
- S Series
- S200 Series
- H Series
- A Series
- AL Series
- B Series

To view more Schlage residential products, plus the full range of Ingersoll Rand door hardware, see the architects, engineers and contractors Sweets catalog file in 08 71 00.



BE-Series

Electronic Keypad Deadbolts



Choose a Plymouth electronic keypad deadbolt paired with a Plymouth handleset in Satin Nickel (619) to give contemporary styling to a classic wood door.

Keeping your home and family secure has never been easier.

Schlage electronic keypad deadbolts can be paired with handlesets, knobs or levers to provide the ultimate in security, convenience and style.

- Quick, easy keyless entry for family members, visitors and service people
- Electronic keypad deadbolts are ready to use right out of the box
- Add, change or delete up to 19 user codes in seconds
- Comes with a 9-volt battery with an average three-year battery life and a low battery indicator
- Can be installed with just a screwdriver in less than 30 minutes
- Fits most standard door preparations
- Illuminated, wear-resistant keypad provides easy visibility
- Visit Schlage.com for demonstration videos on how to use our electronic keypad deadbolt



Choose an electronic keypad deadbolt in our Aged Bronze (716) finish to give your entry old-world style with modern convenience and security.



Electronic keypad deadbolts can be paired with knobs and levers, like this Plymouth deadbolt with our Callington lever in Bright Brass (605).



BE-Series and FE-Series Residential Keypad Deadbolts and Locksets

Keypad Deadbolt Options



BE365-Series Camelot



BE365-Series Plymouth



FE365-Series Camelot x Accent Lever



FE365-Series Camelot x Georgian Knob



FE365-Series Plymouth x Flair Lever



FE365-Series Plymouth x Plymouth Knob

CONVENIENT. SECURE. STYLISH.

Experience keyless freedom with Schlage keypad locks, revolutionary products that bring security to a new level. As beautiful as they are functional, our keypad locks combine the convenience of keyless entry with the superior quality you expect from Schlage. It's the perfect blend of freedom and security.

Security and Quality

- Grade 2 ANSI/BHMA certified
- Patented commercial grade clutching motor drive; tested to one million cycles
- Vandlgard® high security cylinder
- Vandlgard free-spinning deadbolt turn
- Vandlgard clutching knob/lever design
- Code control; 6-digit programming code required to add and delete user codes
- Warning sounds after four incorrect codes entered; keypad disabled for 30 seconds
- Mechanical key override; patent pending

Convenience

- Convenient keyless access; no keys to hide, lose or forget
- Standard door prep; no additional mounting holes required
- Pre-set with random 6-digit programming code and two random 4-digit user codes
- 19 user code capacity; 10,000 user code combinations
- Easily programmed right at the keypad; no need to remove inside escutcheon
- Blue LEDs illuminate the keypad on demand
- Locks can be re-keyed to match existing locks
- 9-volt alkaline battery included

SPECIFICATIONS

Applications: Residential single- and multi-family doors.

Keypad Codes: Pre-set, unique, six-digit programming code; two pre-set unique 4-digit user codes (19 code capacity).

Keying: 5-pin tumbler with two keys per lock. Stock locks are keyed 5-pin

Door Range: 1-3/8" to 1-3/4" thick (35 mm-51 mm) standard.

Backset: Universal latches and deadbolts fit 2-3/8" (60 mm) or 2-3/4" (70 mm) backsets.

STANDARD FEATURES

- Lifetime Limited Mechanical Warranty
- Lifetime Limited Finish Warranty
- 1 Year Electronics Warranty
- Keypad Lock Latch: 1" x 2-1/4" latch with radius corner faceplate, 7/8" housing diameter, 1/2" throw spring latch with Triple-Option™ square corner and circular drive-in faceplates
- Keypad deadbolt latch: 1" x 2-1/4" radius corner faceplate, 1" housing diameter, requires 1" edge bore, 1" throw with dual option radius corner and circular drive-in faceplates
- Latch Strikes: 1-5/8" x 2-1/4", square and radius corner, full lip
- Deadbolt Strike: 1-1/8" x 2-3/4", square corner, latch strike
- Backset: Fits 2-3/8" to 2-3/4" backsets
- Cylinder: 5-pin solid brass, keyed 5-pin, C keyway, keyed different (KD)
- General:
 - Minimum 5-1/2" center-to-center distance between cross bore holes
 - 9-volt battery included with average three-year battery life
 - Silicone rubber, wear-resistant buttons with LED backlight
 - ANSI A 156.5-2001 Grade 2 auxiliary locks, ANSI A 156.2-2003 bored locks and latches
 - FCC Part 15
 - CE mark
 - BE365 available UL Listed (Box Pack Only)

BE-Series and FE-Series Residential Keypad Deadbolts and Locksets

Keypad Entry Lock Options



FE595-Series
Camelot x Accent Lever



FE595-Series
Plymouth x Flair Lever



FE595-Series
Plymouth x Elan Lever



FE595-Series
Camelot x Georgian Knob



FE595-Series
Plymouth x Plymouth Knob



FE575-Series
Camelot x Accent Lever



FE575-Series
Plymouth x Flair Lever



FE575-Series
Plymouth x Jazz Lever



FE595-Series
Plymouth x Jazz Lever



FE575-Series
Plymouth x Plymouth Knob

DIMENSIONS

	Outside Assembly			Inside Assembly			
	Hgt.	Wth.	Dpt.	Hgt.	Wth.	Dpt.	Dia.
BE365 Keypad Deadbolt	5.426"	3.172"	2.186"	5.66"	3.28"	1.847"	—
FE575 Keypad w/ Knob	6.844"	3.012"	3.135"	—	—	2.321"	2.732"
FE575 Keypad w/ Lever	6.844"	3.012"	3.247"	—	—	2.785"	—
FE595 Keypad w/ Knob	6.844"	3.012"	3.135"	5.750"	3.012"	3.178"	—
FE595 Keypad w/ Lever	6.844"	3.012"	3.247"	5.750"	3.012"	3.275"	—

DOOR PREPARATION

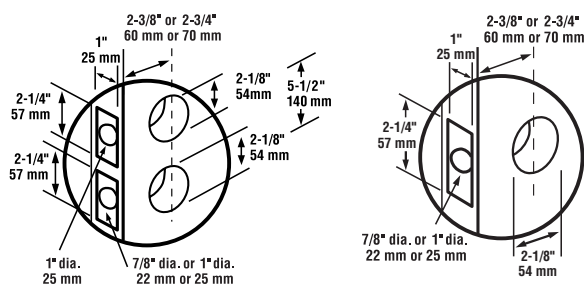

Keypad Entry

FINISHES

See page 20 for Finish Samples

Keypad Locks	505	609	613	619	620	625	626	716
BE365 Camelot	•	•	•	•	•	•	•	•
BE365 Plymouth	•	•	•	•	•	•	•	•
FE365* Camelot x Accent	•			•	•			•
FE365* Camelot x Georgian	•	•		•				•
FE365* Plymouth x Flair	•	•		•	•	•	•	•
FE365* Plymouth x Plymouth	•		•					
FE595 Camelot x Accent	•	•	•	•	•	•	•	•
FE595 Camelot x Georgian	•	•		•				
FE595 Plymouth x Flair	•	•	•	•	•	•	•	•
FE595 Plymouth x Elan								•
FE595 Plymouth x Jazz								•
FE595 Plymouth x Plymouth	•							
FE575 Camelot x Accent	•	•	•	•	•	•	•	•
FE575 Plymouth x Flair	•	•	•	•	•	•	•	•
FE575 Plymouth x Elan								•
FE575 Plymouth x Jazz								•
FE575 Plymouth x Plymouth	•	•						

* FE365 Keypad Deadbolt must be ordered as:

- BE365 Keyed Deadbolt
- FE285 Bottom Half Handleset



= Complies with ADA Accessibility Guidelines



FA-Series and F-Series Residential Entrance Handlesets

Handleset Design Options — FA-Series

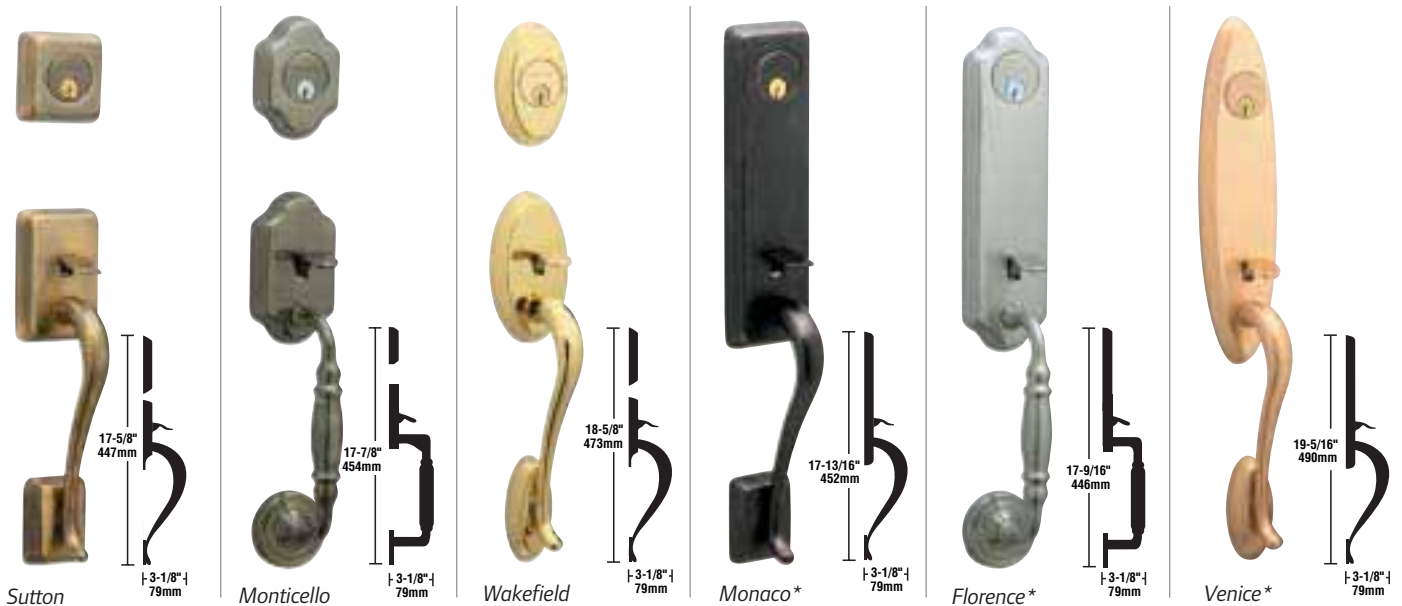

DEADBOLTS, LATCHES & STRIKES

Deadbolt: Furnished with B-Series standard deadbolt.

Latches & Strikes: 1" x 2-1/4" radius corner faceplate, 7/8" housing diameter, 1/2" throw spring latch with Triple-Option square corner and circular drive-in faceplates. UL Listed locks are furnished with #10-001 T strike, 1-1/8" x 2-3/4" (29 mm x 70 mm), 1-1/8" (29 mm) lip (also available with standard product).

Door Frame Reinforcer (37-016): Furnished standard with deadbolts. This unit significantly strengthens a wood jamb against "kick-in" attack and greatly increases the security effectiveness of the lock. The reinforcer is concealed under the strike and is anchored to the jamb with two 3" (76 mm) long screws.

*Available with 1- or 2-piece interior design.

FINISHES

Handlesets	505	605	609	612	613	619	620	622	625	626	716
Addison	•	•				•	•	•	•		•
Bowman	•	•	•					•			
Camelot	•	•	•		•	•	•	•	•		•
Century	•	•	•						•	•	
Parthenon			•								
Plymouth	•	•	•		•	•	•		•	•	•
Florence	•	•	•	•	•	•	•	•	•	•	•
Monaco	•	•	•	•	•	•	•	•	•	•	•
Monticello	•	•	•	•	•	•			•		
Sutton	•	•	•	•	•	•	•		•	•	
Venice	•	•	•	•	•	•			•	•	•
Wakefield	•	•	•	•	•	•	•	•	•	•	•

RESIDENTIAL LOCK FINISH SAMPLES



505
Bright Brass
PVD Finish



605
Bright Brass

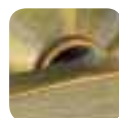

609
Antique Brass



612
Satin Bronze

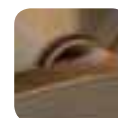

613
Oil Rubbed
Bronze

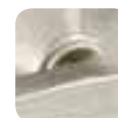

619
Satin Nickel



620
Antique Pewter



622
Matte Black



625
Bright Chrome



626
Satin Chrome

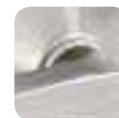

630
Satin Stainless Steel

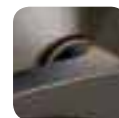

716
Aged Bronze

FA-Series and F-Series Residential Entrance Handlesets

Handleset Design Options — F-Series

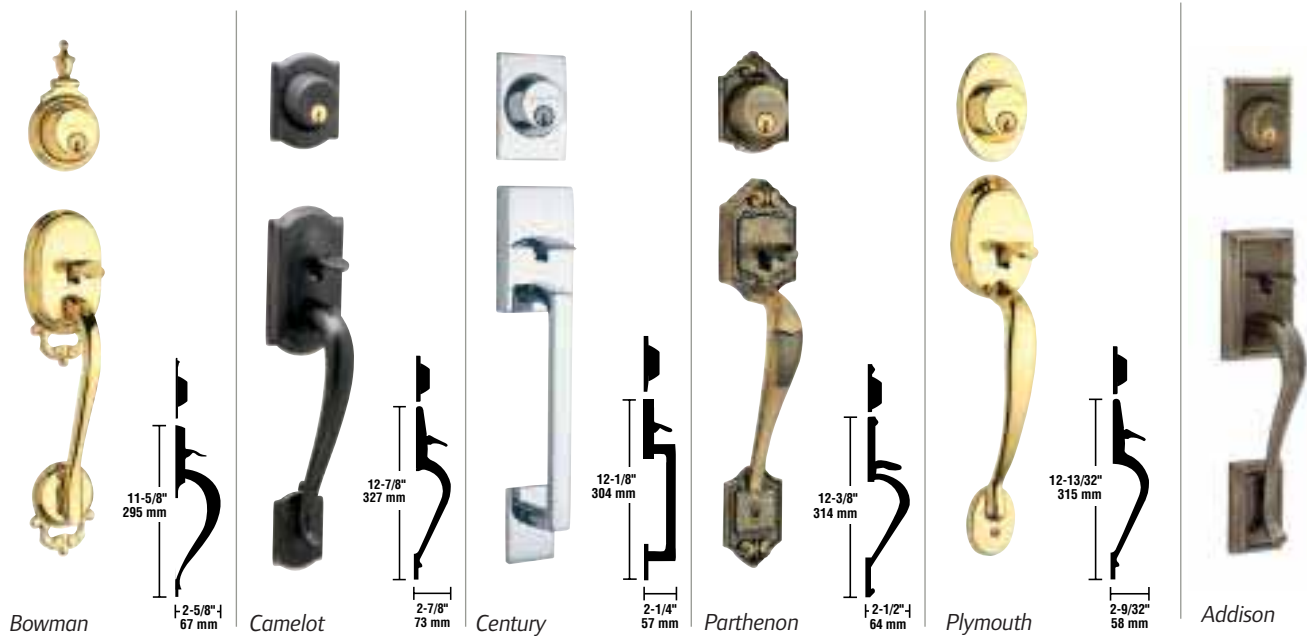

SPECIFICATIONS

Applications: Residential single and multi-family entrance doors.

Exposed Trim: Outside trim: Handlesets are solid forged brass; wrought brass trim rings with concealed security inserts. Inside trim: Wrought brass; levers are pressure cast zinc, plated-to-match finishes indicated.

Interior Trim: The one-piece outside handleset designs can be combined with a one-piece or two-piece interior trim.

Keying: FA-Series handlesets 5-pin tumbler with two keys per lock. Stock locks are keyed 5-pin. F-Series Handlesets: 6-pin tumbler with two keys per lock. Stock locks are keyed 5-pin

Door Range: 1-5/8" to 2" thick (41mm-51mm) standard. Thick door kits available for door thickness up to 2-1/2".

Backset: Universal latches and deadbolts fit 2-3/8" (60mm) or 2-3/4" (70mm) backsets.

Trim Rings and Security Inserts: F-Series and FA-Series handlesets are furnished with 7/8" wrought brass cylinder trim rings. The cylinder trim rings are reinforced by a tapered die cast security insert installed under the trim ring for resistance to wrenching or prying the cylinder unit.

STANDARD FEATURES

- Lifetime Limited Mechanical Warranty
- Lifetime Limited Finish Warranty
- Solid forged brass
- Flush cylinder design
- 1" (25mm) throw deadbolt, 7/8" (22mm) housing standard
- Solid brass pin tumbler cylinder assembled with pick-resistant pins
- Large inside thumbturn for easy operation
- All handleset designs are through-bolted for added security
- Handlesets are designed with an adjustable through-bolt post for easy installation, which can move up and down 1-1/2" to fit a variety of pre-existing holes

DOOR PREPARATION

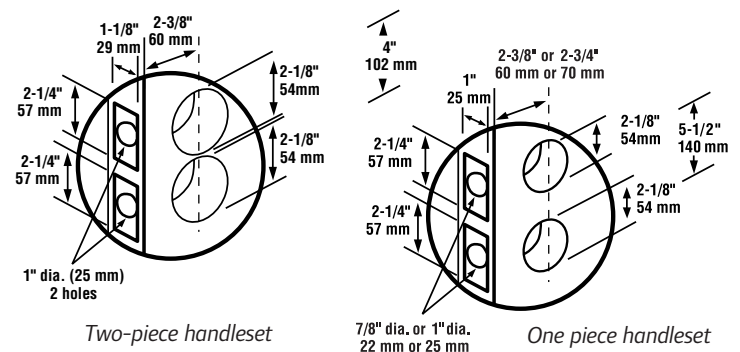

Knob/Lever Design Options — FA-Series

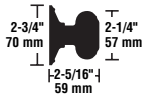

Andover

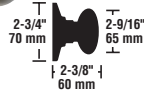

Danbury

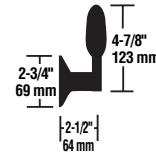

St. Annes

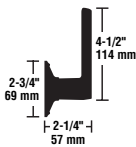

Callington

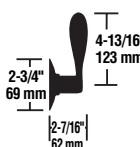

Champagne

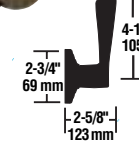

Merano

French Door Escutcheon



Shown with Champagne Lever

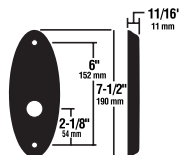

FRENCH DOOR ESCUTCHEON

As a decorative option, french door escutcheons can be added to any F/FA-Series knob or lever function — except for keyed levers (F51/FA51). The french door escutcheons do come standard on the FA patio knob function (FA30).

ADA-COMPLIANT PRODUCTS

In compliance with the American National Standards Institute (ANSI A117.1) and the Americans with Disabilities Act (ADA), Schlage Lock Company offers a wide selection of locks designed for the needs of the physically challenged. These solid lever designs are available as inside trim on handlesets.



= Complies with ADA Accessibility Guidelines

FINISHES

See page 20 for Finish Samples

Knobs	505	605	609	612	613	619	620	622	625	626	716
Siena	•	•	•		•	•	•		•		•
Plymouth	•	•	•		•	•	•	•	•	•	•
Georgian	•	•	•					•			•
Orbit	•	•	•		•	•	•				•
Bell	•	•	•								•
Andover	•	•	•	•	•	•	•	•	•	•	•
Danbury	•	•	•	•	•	•	•	•	•	•	•
Levers											
Avanti	•	•	•		•	•	•		•		•
Accent	•	•	•		•	•	•	•	•	•	•
Flair	•	•	•		•	•	•		•	•	•
Manhattan	•								•		
Jazz	•	•	•			•	•				•
Elan	•	•	•								
Callington	•	•	•	•	•	•	•	•	•		•
Champagne	•	•	•	•	•	•	•			•	•
Merano								•	•	•	•
St. Annes	•	•	•	•	•	•	•		•	•	•

DOOR PREPARATION

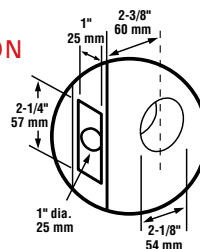

FA-Series and F-Series

Residential Entrance Handlesets

Knob/Lever Design Options — F-Series

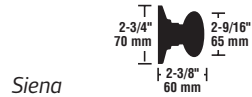

Siena

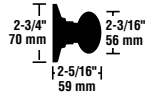

Plymouth

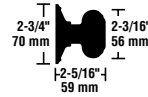

Georgian

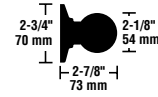

Orbit

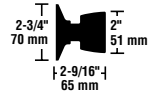

Bell

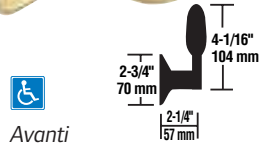

Avanti

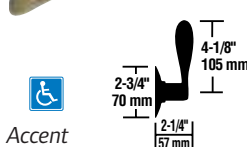

Accent

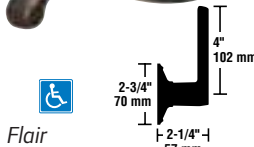

Flair

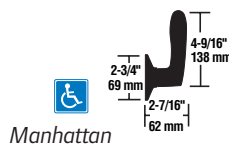

Manhattan

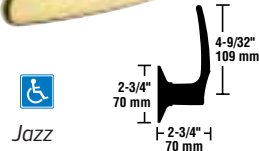

Jazz



Elan

SPECIFICATIONS

Applications: Residential single-and multi-family use.

Certifications: ANSI A156.2, 1996, Series 4000 Grade 2. UL Listed locks for 3-hour fire doors are furnished with #10-001 T strike, 1-1/8" x 2-3/4" (29mm x 70mm), 1-1/8" (29mm) lip (also available with standard product). Assembled to order when specified with "F" suffix. Example: F51F

Exposed Trim: Wrought brass. Levers are zinc-based plated to match finishes indicated.

Keying: 5-pin tumbler C keyway with two keys. All F51 functions offer interior emergency exit feature.

Door Range: 1-3/8" to 1-3/4" (35mm to 44mm) standard. Most functions available for 2" (51mm) doors, specify when ordering.

Backset: Universal latch standard, fits either 2-3/8" (60mm) or 2-3/4" (70mm) backsets.

STANDARD FEATURES

- Lifetime Limited Mechanical Warranty
- Lifetime Limited Finish Warranty
- Concealed screws on FA-Series roses
- Field reversible levers on privacy, passage and keyed functions
- Pressure-cast zinc tubular lock housing
- Key removable outside knobs or levers for easy cylinder replacement
- Meets 400,000 cycle ANSI Grade 2 requirements
- One-piece knob for better security and appearance

LATCHES & STRIKES

Latches: 1" x 2-1/4" (25mm x 57mm), 1/2" (13mm) throw standard. Triple-Option™ faceplates including 1-1/8" (29mm) square corner, 1/4" (6mm) round corner and circular drive-in are standard. 1-1/8" (29mm) faceplate adapters available

Strikes: Full lip, 1-5/8" x 2-1/4" (41mm x 57mm), 1-1/8" (29mm) lip, #10-026, standard. Optional strikes: full lip, 1/4" (6mm) radius round corner; circular drive-in, ANSI 1-1/4" x 4-7/8" (32mm x 124mm), 1-3/16" (30mm) lip. UL Listed locks are furnished with #10-001 T strike, 1-1/8" x 2-3/4" (29mm x 70mm), 1-1/8" (29mm) lip (also available with standard product).



= Complies with ADA Accessibility Guidelines



= Helps meet LEED certification

Handleset/Deadbolt design options

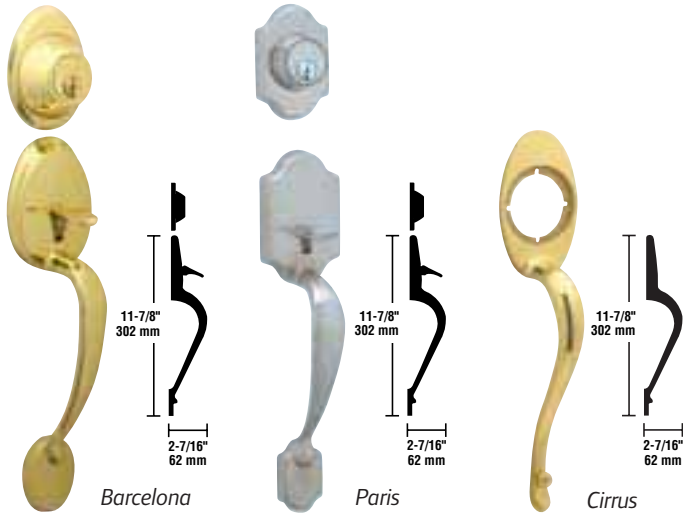

HANDLESET SPECIFICATIONS

- Applications:** Residential single- and multi-family doors.
- Certifications:** ANSI A156.5, 2001, Grade 3.
- Exposed Trim:** Handlesets are solid forged brass; wrought brass trim rings.
- Keying:** Schlage C keyway with three brass keys. Locks are keyed 5-pin.
- Door Range:** 1-3/8" to 1-3/4" (35mm to 44mm) standard.
- Backset:** Universal latch standard, fits either 2-3/8" (60mm) or 2-3/4" (70mm) backsets.
- Warranty:** Lifetime mechanical warranty, five-year finish warranty.
- UL Listing:** Single cylinder deadbolt/handleset available with UL Listing - Box Pack only.

DEADBOLTS, LATCHES AND STRIKES

- Deadbolt Latches:** 1" (25mm) housing diameter, 1" (25mm) throw. Box Pack - Dual Option adjustable bolt with 1" x 2-1/4" (25mm x 57mm) round corner and square corner faceplates standard. Optional drive-in adjustable bolt. Visual Pack - Triple Option adjustable bolt with 1" x 2-1/4" (25mm x 57mm) round corner, square corner and drive-in faceplates standard.
- Spring Latches:** 1" (25mm) housing diameter, 1/2" (15mm) throw. Box Pack - Dual Option adjustable latch with 1" x 2-1/4" (25mm x 57mm) round corner and square corner faceplates standard. Optional drive-in adjustable latch. Visual Pack - Triple Option adjustable latch with 1" x 2-1/4" (25mm x 57mm) round corner, square corner and drive-in faceplates standard.
- Deadbolt Strikes:** 1-5/8" x 2-1/4" (41mm x 57mm) square strike plate and strike frame reinforcer standard. Optional strikes: square full lip, radius full lip 1" x 2-1/4" (25mm x 57mm) and 4-hole radius full lip 1-1/4" x 3-5/8" (32mm x 592mm).
- Latch Strikes:** 1-5/8" x 2-1/4" (41mm x 57mm) radius full lip standard. Optional strikes: Square full lip, square corner.

DEADBOLT SPECIFICATIONS

- Applications:** Single-family and multi-family doors.
- Certification:** ANSI A156.5, 2001 Grade 3.
- Exposed Trim:** Wrought brass or bronze.
- Keying:** Schlage C keyway with two brass keys. Locks are keyed 5-pin.
- Door Range:** 1-3/8" to 1-3/4" (35mm to 44mm) standard.
- Backset:** Universal latch standard, fits either 2-3/8" (60mm) or 2-3/4" (70mm) backsets.
- Warranty:** Lifetime mechanical warranty, five-year finish warranty.
- UL Listing:** Single cylinder deadbolt product available with UL Listing - Box Pack only.

FINISHES

See page 20 for Finish Samples

Handlesets	605	609	619	620	625	630	716
Barcelona	•	•	•	•	•	•	•
Paris	•	•	•	•	•	•	•
Cirrus	•	•	•			•	
Deadbolts							
JD60/62	•	•	•	•	•	•	•
JD80	•	•	•				•
JD81	•	•	•			•	

DOOR PREPARATION

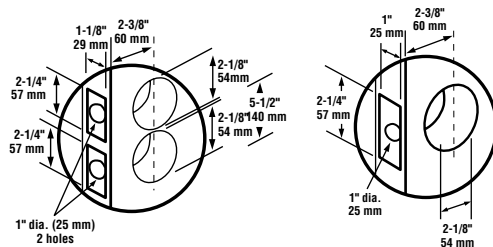

J-Series Residential Lock Sets

Knob/Lever Design Options

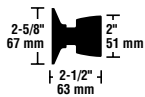

Byron

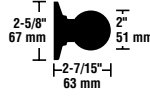

Corona

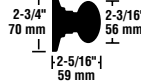

Stratus

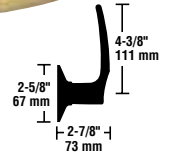

Dover



LaSalle

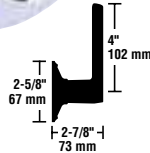

Marin

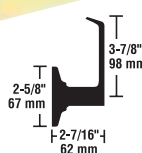

Torino

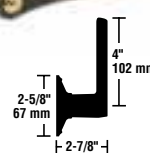

Seville

Note: Dover, Marin and Torino lever designs are non-handed. Specify door handing for LaSalle lever design.

SPECIFICATIONS

Applications: Residential single- and multi-family doors.

Certifications: ANSI A156.2, 1996, Series 4000 Grade 3.

Exposed Trim: Wrought brass or bronze. Levers are zinc-based; plated to match finishes indicated.

Keying: 5-pin tumbler Schlage C keyway with two brass keys.

Door Range: 1-3/8" to 1-3/4" (35mm to 44mm) standard.

Backset: Universal latch standard, fits either 2-3/8" (60mm) or 2-3/4" (70mm) backsets.

UL Listing: Knobs/levers available with UL Listing. Box Pack only.

STANDARD FEATURES

- Lifetime Mechanical Warranty, five-year Finish Warranty
- Schlage C keyways can be keyed to Schlage locks for one-key convenience

LATCHES & STRIKES

Latches: 1" (25mm) housing diameter, 1/2" (15mm) throw. Box Pack - Dual Option adjustable latch with 1" x 2-1/4" (25mm x 57mm) round corner and square corner faceplates standard. Optional drive-in adjustable latch. Visual Pack - Triple Option adjustable latch with 1" x 2-1/4" (25mm x 57mm) round corner, square corner and drive-in faceplates standard.

Strikes: 1-5/8" x 2-1/4" (41mm x 57mm) radius full lip standard. Optional strikes: Square full lip, square corner.

FINISHES

See page 20 for Finish Samples

Knobs	605	609	619	620	625	630	716
Byron	•	•				•	
Corona	•	•	•	•	•	•	•
Stratus	•	•	•		•	•	•
Levers							
Dover	•	•	•		•	•	
LaSalle	•	•	•	•	•	•	•
Marin	•	•	•	•	•	•	
Torino	•	•	•	•	•	•	•
Seville	•	•	•	•	•	•	•

DOOR PREPARATION

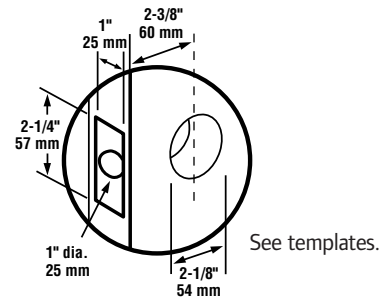

= Complies with ADA Accessibility Guidelines





Interior accessories like our coat hooks come in finishes to match your door hardware and provide a stylish, yet practical, solution for hanging coats, bathrobes, or even dog leashes where they can be grabbed on the go.



Our hinged door stops offer an unobtrusive alternative to traditional baseboard door stops and prevent damage to walls.

Bring polish and style to your home, inside and out.

From the house numbers and door knocker out front, to hinges, door stops and even coat hooks, Ives by Schlage can pull your home's design together both inside and out. Our accessories come in a wide range of finishes that you can match to your existing door hardware, or to fixtures like outdoor lights, interior plumbing hardware or interior light fixtures. A 3-Year Warranty ensures great-looking performance.

- ① eye viewer
- ② door knocker
- ③ electronic keypad deadbolt with handleset
- ④ hinges
- ⑤ address numbers
- ⑥ mail slot
- ⑦ kickplate
- ⑧ coat hooks
- ⑨ hinge door stop

INTERIOR HARDWARE - DOOR STOPS

61 Solid Door Stop

- Available in three sizes to accommodate varying areas of installation and door trim dimensions
- Rubber tip is replaceable
- Projection: 3-1/8" on brass units. 3-3/16" on aluminum units
- Made from solid brass, aluminum, or epoxy-colored aluminum
- Finishes: B3 (B-605), B4, B5, B10, B10B (B-613), B14, B15 (B-619), B15A (B-620), B26 (B-625), B26D, A3, A4, A5, A10, A10B, A14, A26, A92, A-A (Almond Epoxy Coated), A-W (White Epoxy Coated), A-BLK (Black Epoxy Coated)



63 Flex Door Stop

- Made from steel
- Projection: 3"
- Simple to install



221 Flush Pull

- Ideal for use on sliding doors
- Built-in prong design eliminates the need for screws or brads and facilitates installation
- Packed with two escutcheon pins for added holding power
- Made from wrought brass
- Conforms to design requirements of ANSI/BHMA A156.9 B22201 and A156.14 D2781
- Finishes: B3, B4, B5, B10, B10B, B14, B15, B15A, B19, B26, B26D



Inside Cup Diameter: 2-1/8"
Overall Diameter: 2-7/16"
Depth: 7/16"

263 Manual Flush Bolt

- Solid brass
- Dimension: 5" x 3/4"
- Finishes: B3, B5, BDB, B26, B26D, B15, B15A



EXTERIOR HARDWARE - EYE VIEWERS

U696

- 150° angle of view
- For doors 1-3/8" to 2-1/16" thick
- Secure, tamper-resistant
- Solid brass body; glass lens
- Simple installation — only a 1/2" hole required
- Suggested installation height: 60" from floor
- Trim washer available, 3/4" x .032" thick
- UL Listed for use on fire door assemblies rated at 90 minutes
- Conforms to ANSI/BHMA L23172 and L23222
- Finishes: B4, B26D



U698

- 190° angle of view
- Lens projects 1/4" from face of door
- 4 optical glass lenses
- For doors 1-3/8" to 2-1/8" thick
- Solid brass body and barrel
- Simple installation — only a 9/16" hole required
- Suggested installation height: 60" from floor
- U698 is UL Listed for use on fire door assemblies rated at 90 minutes
- Conforms to ANSI/BHMA A156.16 L23172 and L23222
- Finishes: B3, B26D



EXTERIOR HARDWARE - KICK PLATES

8400 — Residential Grade

- .037 gauge

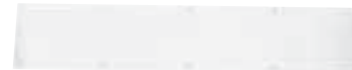

Finishes Size

B3 6" x 30", 6" x 34", 8" x 30", 8" x 34"

B5 6" x 30", 6" x 34", 8" x 34"

613 6" x 30", 6" x 34", 8" x 34"

619 6" x 30", 6" x 34", 8" x 30", 8" x 34"

620 6" x 30", 6" x 34", 8" x 30", 8" x 34"

625 6" x 30", 6" x 34", 8" x 34"

PA3 6" x 30", 6" x 34", 8" x 30", 8" x 34"

PA28 6" x 30", 6" x 34", 8" x 30", 8" x 34"

EXTERIOR HARDWARE - MAIL SLOTS



618

- 7-1/2" x 2" opening
- Finishes: A63



620

- 11" x 2" opening
- Finishes: B3, 505, B4, B5, 626, B10, B10B, B15, B15A, B26, B613 and PA28



626

- 7-1/2" x 1-7/8" opening
- Finishes: B3, 505, 626, B4, B5, B10, B10B, B14, B15, B15A, B26 and PA28

Builders Hardware

HAND RAIL BRACKET

059

- Made from solid brass, cast aluminum or epoxy coated aluminum
- Finishes: B3, B4, B5, B10, B10B, B14, B15, B15A, B26, B26D, A3, A4, A5, A10, A10B, A14, A26, A92, A-A, A-W, A-BLK
- Base: 2-1/4" x 1-3/8"

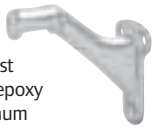

HAND RAIL BRACKET

59

- Made from cast brass or aluminum
- Finishes: B3, B4, B5, B10, B10B, B14, B15, B15A, B26, B26D, A3, A4, A5, A10, A10B, A14, A26, A92, A-A, A-W, A-BLK
- Brass base: 2-15/16" x 1-1/2"



HINGE PIN DOOR STOP

69

- Steel construction
- Removable bushings accommodate 1/4" to 5/16" diameter hinge pins
- Finishes: F3, F5, F10, F10B, F14, F15, F15A, F26, F26D



HINGE PIN DOOR STOP

70

- Solid brass or aluminum
- Removable bushings accommodate 1/4" to 5/16" diameter hinge pins
- Finishes: B3, B4, B5, B10, B10B, B14, B15, B15A, B26, B26D, A3, A4, A5, A10, A10B, A14, A26, A92, A-A, A-W, A-BLK



WINDOW LOCK

4

- Made from solid brass or steel
- Finishes: Brass-B3, B4, B5, B10, B10B, B14, B15, B15A, B26, B26D Steel-F3, F4, F10, F14, F15, F15A, F26, F26D
- Base - 1-3/8" x 2-5/16"
- Strike - 9/16" x 2-1/4"



WINDOW LOCK

07

- Solid brass or aluminum
- Finishes: Brass-B3, B4, B5, B10, B10B, B14, B15, B15A, B19, Aluminum-A3, A4, A5, A10, A14, A92, A-A, A-BLK and A-W
- Base - 15/16" x 2-9/16"
- Strike - 5/8" x 2-9/16"



BAR WINDOW LIFT

026

- Solid brass or aluminum
- Finishes: Brass-B3, B4, B5, B10, B10B, B14, B15, B1A, B19, B26, B26D Aluminum-A3, A5, A14, A92
- Base - 1-1/8" x 4"



HOOK WINDOW LIFT

14

- Made from cast brass or steel
- Finishes: Brass-B3, B4, B5, B10, B10B, B14, B15, B15A, B19, B26, B26D Steel-F3, F14
- Base - 1-1/8" x 4"
- 3/4" Projection



DOOR GUARD CHAIN

481

- Wrought brass or steel
- Meets design requirements of ANSI/ BHMA A156.16
- Finishes: Brass-B3, B4, B5, B10, B10B, B15, B26, B26D. Steel-F3, F5, F15



SOLID DOOR GUARD

482

- Cast brass or aluminum
- Meets design requirements of ANSI/ BHMA A156.16
- Strike Plate - 2-5/8" x 1-1/32"
- Arm Length - 4-3/4"
- Finishes: Brass-B3, B4, B5, B10B, B15, B26, B26D. Aluminum- A3, A5, A26, A26D



SECURITY DOOR BOLT

87

- Solid Brass
- Finishes: B3, B4, B5, B10, B10B, B15, B26, B26D
- Throw - 5/8"
- Length - 2-1/4" Width - 1-1/4"

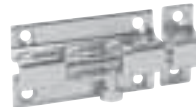

STORM DOOR LATCH

980

- For wood storm doors 7/8" - 1-1/8" thick
- Security lock operates from inside rose
- Wrought brass construction
- Finishes: B3, B5, B10B, B15, B15A, B26, B26D
- Backset - 1-3/4"
- Rose Diam. - 1-7/8"



BALL CATCH

348

- Wrought Brass
- Finishes: B3, B4, B5, B10, B10B, B15, B15A, B26, B26D
- Face Plate - 2-1/8" x 1"
- Strike - 2-1/8" x 1-1/16"



BALL CATCH

349

- Wrought brass or steel
- Finishes: B3, B4, B5, B10, B10B, B15, B15A, B26, B26D
- Face Plate - 2-1/8" x 1"
- Strike - 2-1/8" x 1-3/8"



WALL GUARD

WS407CVX

- Wrought brass, aluminum or steel
- Convex rubber bumper
- Finishes: US3, US4, US5, US10, US10B, US14, US15, US26, US26D, US28, US32D



WALL GUARD

WS407CCV

- Wrought brass, aluminum or steel
- Concave rubber bumper
- Finishes: US3, US4, US5, US10, US10B, US14, US15, US26, US26D, US28, US32D



Lever Design Options



Saturn
S51PD



Flair

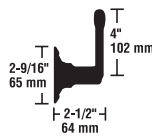

Jupiter

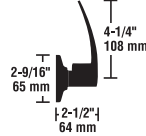

Neptune

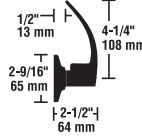

Saturn

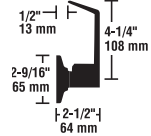

SPECIFICATIONS

Applications: Interior light- to medium-duty commercial doors: office tenant, laboratory, passage and entrance doors. Heavy-duty residential doors: single- and multi-family housing.

Certifications: ANSI A156.2, 1996, Series 4000 Grade 2. UL/cUL Listed for all functions up to 3-hour doors.

Exposed Trim: Levers are pressure-cast zinc, plated to match finishes indicated. Roses, latch faceplates and strikes are wrought brass or bronze.

Keying: 6-pin tumbler with two nickel silver keys per lock. Stock locks are keyed 6-pin in an Everest C123 keyway. Other keying options available from the factory include master keying, grand master keying, construction keying and interchangeable core. For maximum key control, Classic Primus XP and Everest Primus cylinders are available.

Door Range: 1-3/8" to 2" (35mm to 51mm), except S40D: 1-3/8" to 1-7/8" (35mm to 48mm).

Backset: Universal backset latches standard, fit either 2-3/8" (60mm) or 2-3/4" (70mm) backsets. 5" (127mm) backset latches available.

Deadlatches: Latches are furnished in brass, bronze or chrome finishes, compatible with lock trim. All S-Series latches have a 1/2" (13mm) throw. Orders for complete locks are provided with a C506-815 sleeve for latches installed in doors with 1" (25mm) edge bore.

Strikes: Square corner, 1-1/8" x 2-3/4" x 3/32" (29mm x 70mm x 2mm) T strike with 1-1/8" (29mm) lip, furnished with dust box, #10-001 is standard. Optional lip lengths 1" to 2" (25mm to 51mm). 1/4" (6mm) radius round corner strikes and ANSI 1-1/4" x 4-7/8" (32mm x 124mm) strikes are also available.



= Complies with ADA Accessibility Guidelines



= Helps meet LEED certification

STANDARD FEATURES

- Exceeds 400,000 cycle ANSI Grade 2 requirements
- Exceeds 450 Lbf-locks lever torque ANSI Grade 2 requirements
- Interlocking chassis and latchbolt
- Snap-on inside rose conceals mounting screws
- Key removable outside lever for quick and easy cylinder replacement
- S-Series products installed on educational facilities are not under warranty

ADA-COMPLIANT PRODUCTS

In compliance with the American National Standards Institute (ANSI A117.1) and the Americans with Disabilities Act (ADA), Schlage Lock Company offers a wide selection of locks designed for the needs of the physically challenged.

Designed and manufactured for use on heavy-duty residential and light- to medium-duty interior commercial doors.

FINISHES

See Finish Chart on Page 44

Levers	605	606	609	612	613	625	626
Flair	•	•	•	•	•	•	•
Jupiter	•	•			•	•	•
Neptune	•	•	•		•	•	•
Saturn	•	•	•	•	•	•	•

DOOR PREPARATION

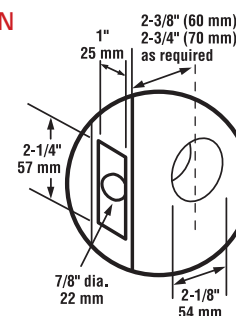

S200-Series Interconnected Locks

Lock Design Options

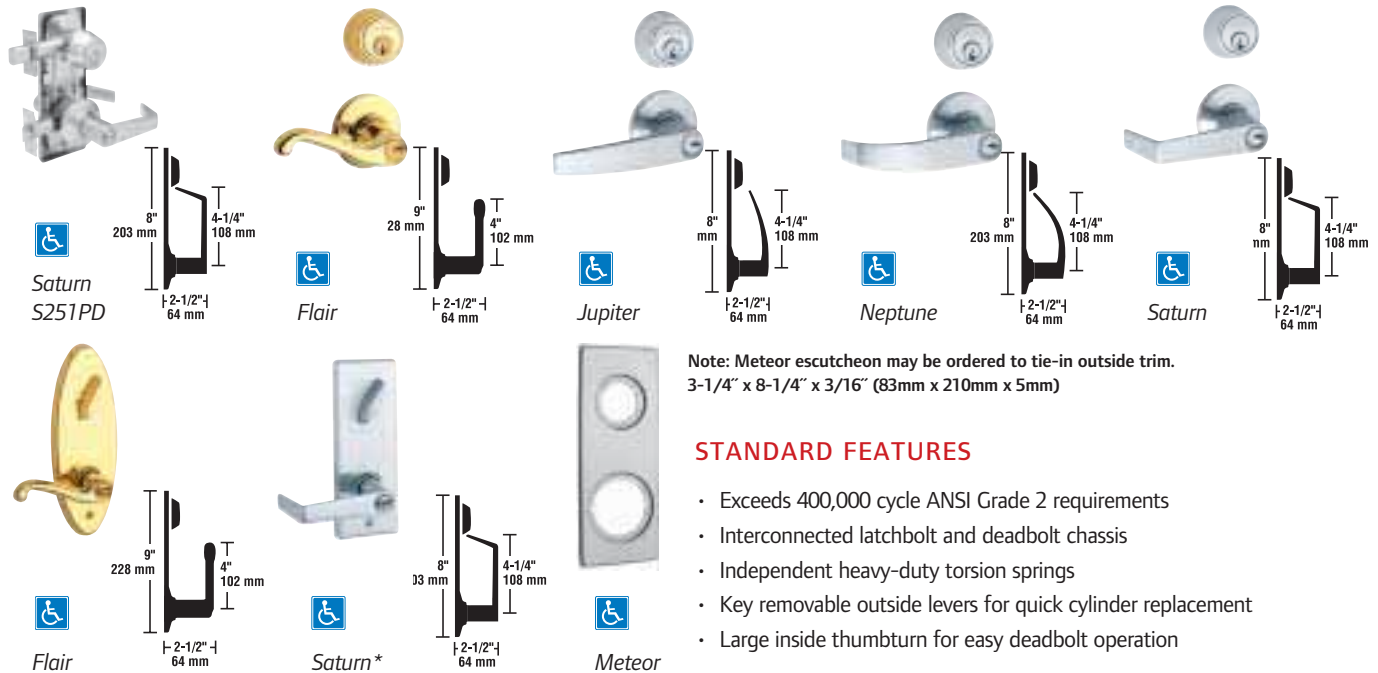

Note: Meteor escutcheon may be ordered to tie-in outside trim.
3-1/4" x 8-1/4" x 3/16" (83mm x 210mm x 5mm)

STANDARD FEATURES

- Exceeds 400,000 cycle ANSI Grade 2 requirements
- Interconnected latchbolt and deadbolt chassis
- Independent heavy-duty torsion springs
- Key removable outside levers for quick cylinder replacement
- Large inside thumbturn for easy deadbolt operation

ADA-COMPLIANT PRODUCTS

In compliance with the American National Standards Institute (ANSI A117.1) and the Americans with Disabilities Act (ADA), Schlage Lock Company offers a wide selection of locks designed for the needs of the physically challenged.

SPECIFICATIONS

Applications: Single- and multi-family residential, office, hotel/motel and commercial applications. Simultaneous latch and bolt retraction for rapid exit.

Certifications: ANSI A156.12, 1992, Grade 2. UL/cUL Listed for all functions for up to three-hour doors.

Exposed Trim: Levers are zinc based, plated to match finishes indicated. Roses and escutcheons, latch faceplates, strikes and Meteor escutcheons (36-056) are wrought brass or bronze.

Keying: 6-pin tumbler with two nickel silver keys per lock. Stock locks are keyed 6-pin in an Everest C123 keyway. Other keying options available from the factory include master keying, grand master keying, construction keying and interchangeable core. For maximum key control, Classic Primus XP and Everest Primus cylinders are available.

Door Range: 1-3/8" to 2" (35mm to 51mm).

Backset: 2-3/8" (60mm) standard. 2-3/4" (70mm) and 5" (127mm) backsets available.

Latches: 1-1/8" (29mm) x 2-1/4" (57mm), 1/2" (13mm) throw. 7/8" (22mm) housing latches are provided with 1" (25mm) sleeves as standard.

Deadbolt: 1" (25mm) throw stainless steel deadbolt is standard.

Strikes: Furnished with standard B600-Series and S-Series strikes. Optional B600-Series and S-Series strikes available.

*Inside Saturn design escutcheon also used for Jupiter and Neptune designs.

U.S.A. 1.800.847.1864 | Canada 1.905.403.1800 | www.schlage.com

FINISHES

See Finish Chart on Page 44

Levers	605	606	609	612	613	619	625	626
Jupiter	•	•		•	•	•	•	•
Neptune	•	•	•	•	•	•	•	•
Omega	•	•	•	•	•	•	•	•
Saturn	•	•	•	•	•	•	•	•
Flair	•	•	•	•	•	•	•	•

DOOR PREPARATION

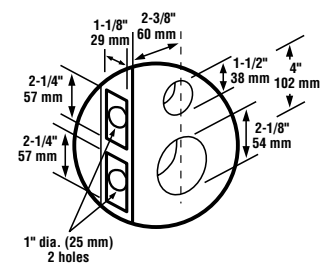

 = Helps meet LEED certification

Knob and Lever Design Options



Orbit



Plymouth

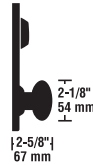

Levon
Inside only



Meteor
3-1/4" x 8-1/4" x 3/16"
(83mm x 210mm x 5mm)

Note: All inside escutcheons 2-3/4" x 6-15/16" x 5/32" (70mm x 176mm x 4mm)

SPECIFICATIONS

Applications: An ideal entrance lock that is well suited for single- and multi-family residential dwellings, as well as commercial applications. The interconnected H-Series provides the security of deadbolt locking with the ease and convenience of a standard cylindrical chassis. The lock features simultaneous retraction of both the latch and the deadbolt from the inside by turning the knob/lever, providing panic-proof exiting.

Exposed Trim: Knobs, inside escutcheon and trim rings are wrought brass or bronze. Trim rings and levers are zinc-based, plated to match BMHA finishes indicated.

Keying: 5-pin tumbler with two nickel silver keys per lock. Stock locks are keyed 6-pin in an Everest C123 keyway. Other keying options available from the factory include master keying, grand master keying, construction keying and interchangeable cores. For maximum key control, Classic Primus XP and Everest Primus cylinders are available.

Door Range: Knob and lever locks, 1-3/4" (44mm) standard [1-11/16" to 1-15/16" (43mm to 49mm)]. Also available for 1-3/8" (35mm) doors. Specify door thickness when ordering H-Series locks for other than standard door thicknesses.

Backset: 2-3/8" (60mm) standard, 2-3/4" (70mm), and 5" (127mm) available.

Door Frame Reinforcer (37-016): Furnished with standard deadbolts. This unique device significantly strengthens a wood door jamb against "kick-in" attack and greatly increases the security effectiveness of the lock. The reinforcer is concealed under the strike and is anchored to the jamb with two 3" (76mm)-long screws.

Meteor Escutcheon (36-056): Material: wrought brass or bronze. Size: 3-1/4" x 8-1/4" x 3/16" (83mm x 210mm x 5mm). The Meteor escutcheon may be ordered as an accessory to tie-in outside trim.

STANDARD FEATURES

- Combines standard cylindrical A-Series lock chassis with added security and strength of a deadbolt
- Patented wood frame reinforcer for deadbolt
- 1" throw deadbolt with hardened steel roller resists swing
- No exposed mounting screws
- Three-year limited warranty

LATCHES & STRIKES

Latches: 1" x 2-1/4" (25mm x 57mm), 1/2" (13mm) throw A-Series latches with 7/8" (22mm) housings standard. All A-Series latches available.

Strikes: Furnished with standard A-Series and BC100-Series strikes. Optional A-Series and B-Series strikes available.

Deadbolt: 1" (25mm) throw B250-Series deadbolts with concealed hardened steel rollers, 1" x 2-1/4" (25mm x 57mm) faceplates, and 7/8" (22mm) housings standard.

DOOR PREPARATION



Orbit
H153

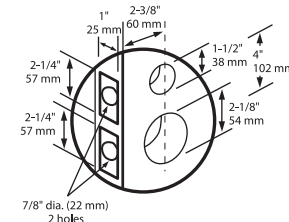

FINISHES

See Finish Chart on Page 44

Knobs/Levers	605	606	609	610	611	612	613	616	625	626
Levon	•					•	•			•
Orbit	•	•	•	•	•	•	•	•	•	•
Plymouth	•	•	•	•	•	•	•	•	•	•
Escutcheon										
Meteor (36-056)	•	•	•			•	•		•	•

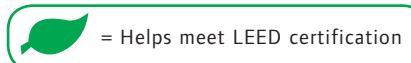

King Cobra 2

Introducing the King Cobra 2 Deadbolt. Electronic keyless entry for multi-family applications.

The New King Cobra 2 Deadbolt from Schlage provides controlled, credentialed and auditable access to your multi-family property. The King Cobra 2 Deadbolt can be managed and programmed using our SMS Express software and SNAP programmer, making your security management system more flexible, and ensuring the safety and security of residents and employees.

KC-2 is ideal for use such areas as:

- office doors
- laundry rooms
- conference rooms
- clubhouse doors
- fitness centers
- equipment rooms
- pedestrian entrance gates
- storage rooms

Individual Code	1000
Keypad/Buttons	N/A
Credentials	iButton
Battery Life	30,000 cycles/2-3 years
Battery Type	9v
Programming	SNAP, SMS



Knob/Lever Design Options



Orbit
A53PD



Georgian

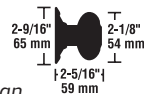

Orbit

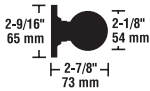

Plymouth

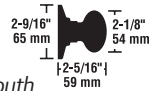

Tulip

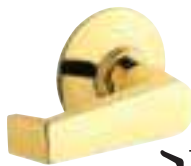
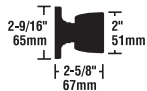

Levon

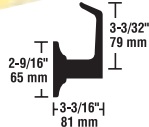

Note: Levon is available on inside only of deadlatch and keyed functions.

SPECIFICATIONS

Applications: Heavy-duty residential, light-and medium-duty commercial.

Certifications: ANSI A156.2, 1996, Series 4000 Grade 2. (Formerly FF-H-106C Series 160.) UL/cUL Listed for all functions up to three hours.

Exposed Trim: Wrought brass, bronze or stainless steel. Lever is zinc based, plated to match BHMA finish symbols.

Keying: 6-pin tumbler with two nickel silver keys per lock. Stock locks are keyed 5-pin. Other keying options available from the factory include master keying, grand master keying, construction keying and interchangeable core.

Door Range: 1-3/8" to 1-7/8" (35mm to 48mm) standard. 2" to 2-1/2" (51mm to 64mm) doors extended inside, regular parts assembled to order.

Backset: 2-3/8" (60mm) standard. 2-3/4" (70mm) and 3-3/4" (95mm) backset latches available. 5" (127mm) backset links available.

STANDARD FEATURES

- Cylindrical lock housing; cold rolled steel, corrosion treated for normal atmospheric conditions
- Key removable outside knobs for easy cylinder replacement
- Solid brass 6-pin cylinders
- No exposed mounting screws
- Meets or exceeds 400,000 cycle ANSI Grade 2 requirements
- Three-year limited warranty

LATCHES & STRIKES

Standard latches and strikes have bronze faceplates, furnished in compatible lock trim finishes.

Latches: 1" x 2-1/4" (25mm x 57mm), 1/2" (13mm) throw standard. 1-1/8" (29mm) wide faceplates available. Circular drive-in, 1/4" (6mm) round corner springlatches and deadlatches are also available.

Strikes: Square corner, 1-1/8" x 2-3/4" x 3/32" (29mm x 70mm x 2mm) T strike with 1-1/8" (29mm) lip, furnished with dust box, standard. Optional lip lengths 1" to 2" (25mm to 51mm) available. ANSI 1-1/4" x 4-7/8" (32mm x 124mm) strike, 1-3/16" (30mm) lip available.

DOOR PREPARATION

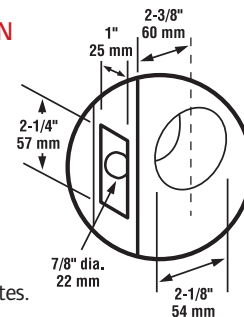

See templates.

FINISHES

See Finish Chart on Page 44

Knobs	605	606	609	610	611	612	613	616	625	626	629	630
Georgian	•	•	•	•					•	•		
Orbit	•	•	•	•	•	•	•	•	•	•		
Plymouth	•	•	•	•	•	•	•	•	•	•	•	•
Tulip	•	•	•	•					•	•		
Levers												
Levon	•					•	•			•		



= Complies with ADA Accessibility Guidelines



= Helps meet LEED certification

AL-Series

Heavy-Duty Residential & Standard-Duty Commercial Locks

Lever Design Options



SPECIFICATIONS

Applications: Standard-duty commercial exterior and interior doors for medical, office, hotel/motel, public buildings, religious, multi-family, retail/storefront and government facilities. Also available for heavy-duty residential use.

Certifications: ANSI A156.2, 1996, Series 4000 Grade 2. Meets A117.1 accessibility code. UL/cUL Listed for all functions up to three-hour doors.

Exposed Trim: Wrought brass or bronze. Levers are pressure-cast zinc, plated to match BHMA finish symbols.

Keying: 6-pin tumbler with two nickel silver keys per lock. Stock locks are keyed 6-pin in an Everest C123 keyway. Other keying options available from the factory include master keying, grand master keying, and construction keying. Interchangeable core available in Saturn design only. For higher key control, Classic Primus XP and Everest Primus cylinders are available.

Door Range: 1-3/8" to 1-7/8" (35mm to 48mm) standard. 1-7/8" to 2" (48mm to 51mm) regular parts assembled to order.

Backset: 2-3/4" (70mm) standard. 2-3/8" (60mm) and 3-3/4" (95mm) backset latches available. 5" (127mm) backset links also available.

DOOR PREPARATION

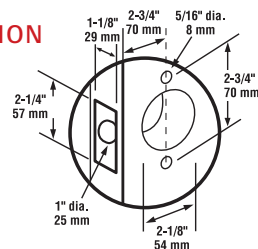

STANDARD FEATURES

- Meet or exceed all ANSI A156.2, 1996, Series 4000 Grade 2 strength and operational requirements, including 400,000 cycle testing
- True through-bolting of door prevents lock chassis rotation and disengagement from latch
- Cold-rolled steel interlocking spindle design for added strength against excess force
- Cold-rolled steel and machined, threaded hubs and locking nuts prevent loosening of the lockset by bolting chassis to the door
- Heavy-duty compression springs extend life of spring cage, minimize droop, provide smooth, fast return action of levers and minimize droop
- Patented door range adjuster allows quick and easy adjustment of the AL-Series for 1-3/8" to 1-7/8" (35mm to 48mm) thick doors
- Three-year limited warranty
- AL-Series products installed on educational facilities are not under warranty

LATCHES & STRIKES

Standard latches and strikes have brass or bronze faceplates, furnished in compatible lock trim finishes.

Latches: 1-1/8" x 2-1/4" (29mm x 57mm), 1/2" (13mm) throw standard. 1" (25mm)-wide faceplates available. Circular drive-in, 1/4" (6mm) radius round corner springlatches and deadlatches are also available.

Strikes: ANSI 1-1/4" x 4-7/8" (32mm x 124mm) strike, 1-3/16" (30mm) lip standard. Square corner, 1-1/8" x 2-3/4" x 3/32" (29mm x 70mm x 2mm) T strike with 1-1/8" (29mm) lip, furnished with dust box, available. Optional lip lengths 1" thru 2" (25mm-51mm) available.

ADA-COMPLIANT PRODUCTS

In compliance with the American National Standards Institute (ANSI A117.1) and the Americans with Disabilities Act (ADA), Schlage Lock Company offers a wide selection of locks designed for the needs of the physically challenged.

FINISHES

See Finish Chart on Page 44

Levers	605	606	609	612	613	619	625	626
Jupiter	•	•		•	•	•	•	•
Neptune	•	•	•	•	•	•	•	•
Omega	•	•	•	•	•	•	•	•
Saturn	•	•	•	•	•	•	•	•

 = Helps meet LEED certification



B-Series Residential and Commercial Deadbolt Locks

Deadbolt Options



BA360
BA300-Series
Single Cylinder



BA362T
BA300-Series
Double Cylinder

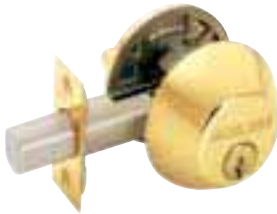

B360N
B300-Series
Single Cylinder



B362T
B300-Series
Double Cylinder

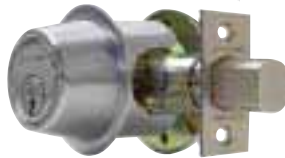

B560P
B500-Series
Single Cylinder



B562PT
B500-Series
Double Cylinder

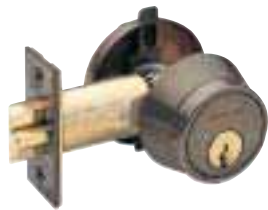

B250PD
B250-Series
Nightlatch



B660P
B600/700/800-Series
Single Cylinder



B662Pt
B600/700/800-Series
Double Cylinder

†Caution: Double cylinder locks on residences and any door in any structure which is used for egress are a safety hazard in times of emergency and their use is not recommended. Installation should be in accordance with existing codes only.

HEAVY-DUTY RESIDENTIAL/LIGHT-DUTY COMMERCIAL

The B300-Series and BA300-Series deadbolts feature easy installation and a 1" (25mm) throw deadbolt, with a concealed hardened steel roller to prevent cutting or sawing the bolt. The BA300-Series includes additional decorative features such as concealed screws, and decorative roses and thumbturn designs.

STANDARD-DUTY GRADE 2 COMMERCIAL/NIGHTLATCH

The BC500-Series deadbolt features a 1" (25mm) throw with a concealed hardened steel roller to prevent cutting or sawing the bolt. The 1" (25mm) reinforced trim ring rotates to protect against wrenching the cylinder. Solid brass 6-pin cylinder for added protection and durability. Solid metal dust box reinforcer with 3" (75mm) steel screws protect against kick-in attack.

The B250-Series nightlatch features a 9/16" (14mm) deadlatch that prevents "shimming" the bolt with a credit card or similar tool. A "hold-back" feature retains the deadlatch in a retracted position when desired. Trim rings are reinforced with hardened steel inserts. Brass or bronze faceplates are self-adjusting for beveled door edges. Also available less "hold-back" feature and with double cylinder.†

HEAVY-DUTY GRADE 1 COMMERCIAL

The B600-Series are Schlage's highest grade deadbolt locks, featuring solid brass or bronze rotating trim rings 7/8" (22mm). Bolts are made of a strong steel alloy, with a concealed hardened steel roller to prevent cutting or sawing. Mounting screws are protected against drilling by steel balls.

SPECIFICATIONS

Applications: Auxiliary and primary locking for residential and commercial buildings. B-Series locks are designed to meet various security door preparations and functional requirements determined by local codes and life safety regulations.

Certifications: ANSI A156.5, 1992. B250, BA300, B500-Series Grade 2; B600-Series, Grade 1. B300, BA300 and B600-Series are UL/cUL Listed as an auxiliary lock for all functions up to three-hour doors.

Exposed Trim: BA300, B300-Series: Wrought brass or bronze. B600-Series: Solid brass or bronze with pressure-cast zinc thumbturn, plated to match finishes indicated. B250 and B500-Series: Wrought brass or bronze with steel security inserts.

FINISHES

See Finish Chart on Page 44

Series	505	605	606	609	611	612	613	619	620	622	625	626	716
B300	•	•		•			•	•	•		•	•	•
BA300	•	•				•	•	•	•	•	•	•	•
B500		•		•		•	•	•			•	•	•
B250	•	•	•		•	•	•					•	
B600	•	•	•	•		•	•	•			•	•	•

= Helps meet LEED certification B600-Series only

B-Series

Residential and Commercial Deadbolt Locks

SPECIFICATIONS CONT.

Keying: B250, BA300 and B300-Series: 5-pin tumbler standard with two nickel silver keys per lock. Available with 6-pin tumblers, assembled to order. B500 and B600-Series: 6-pin tumbler standard with two keys per lock. Other keying options for B-Series available from the factory include master keying, grand master keying and construction keying.

DOOR RANGE

Door* Thickness	Deadbolt Series	Kits available for Doors up to...
1-3/8" to 1-3/4" thick (35mm to 44mm) Standard	B250	2-3/4" (70mm) assembled to order
	BA300	2-1/4" (57mm) assembled to order
	B300	2-1/4" (57mm) assembled to order
1-3/4" to 2" thick (35mm to 51mm) Standard	B500	4" (102mm) assembled to order
	B600	1-3/8" (35mm) and doors up to 2-1/2" (63mm) assembled to order

* Door ranges may vary by function

Backset: B250-Series: 2-3/8" (60mm) standard. 2-3/4" (70mm) available. B500-Series: 2-3/8" (60mm) or 2-3/4" (70mm) adjustable backset standard. BA300 and B300-Series: 2-3/8" (60mm) or 2-3/4" (70mm) universal backset deadbolt standard. B600-Series: 2-3/4" (70mm) standard. 2-3/8" (60mm), 3-3/4" (95mm), 5" (127mm) available.

DOOR FRAME REINFORCER

37-016

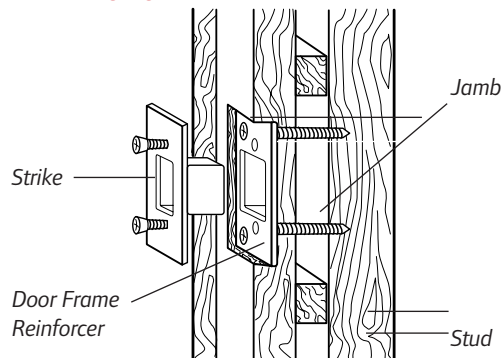

All B-Series deadbolt locks are furnished standard with the door frame reinforcer. This unit significantly strengthens a wood jamb against kick-in attack and greatly increases the security effectiveness of the lock. The reinforcer is concealed under the strike and is anchored to the jamb with 3"-(76mm) long screws.

Adapter Rings

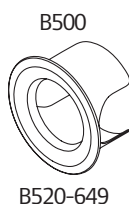

Adapter rings are provided as standard for the B250-Series and B500-Series locks for 2-1/8" (54mm) door preparations.

DEADBOLTS & STRIKES

Standard deadbolts and strikes have brass, bronze or steel faceplates, furnished in compatible lock trim finishes.

Deadbolts: BA300 and B300: 1" x 2-1/4" (25mm x 57mm) round corner. B500-Series: 1" x 2-1/4" (25mm x 57mm) square corner. 1" (25mm) throw standard. Circular drive-in, 1/4" (6mm) round corner deadbolts are also available.

B250-Series: 1-1/8" x 2-1/4" (29mm x 57mm), 9/16" (14mm) throw standard.

B600-Series: 1-1/8" x 2-1/4" (29mm x 57mm), 1" (25mm) throw standard. Circular drive-in deadbolts also available.

Strikes: BA300, B300, B500, B600-Series: Square corner, 1-1/8" x 2-3/4" (29mm x 70mm) strike, no lip, furnished with metal dust box standard. ANSI 1-1/4" x 4-7/8" (32mm x 124mm) with 1-3/16" (30 mm) lip, drive-in and full lip strikes are also available.

B250-Series: Square corner, 1-1/8" x 2-3/4" (29mm x 70mm) strike with 1-1/8" (29mm) lip, furnished with dust box, standard. Optional lip lengths 1" thru 2" (25mm-51mm) available. ANSI 1-1/4" x 4-7/8" (32mm x 124mm) with 1-3/16" (30mm) lip also available.

DOOR PREPARATION

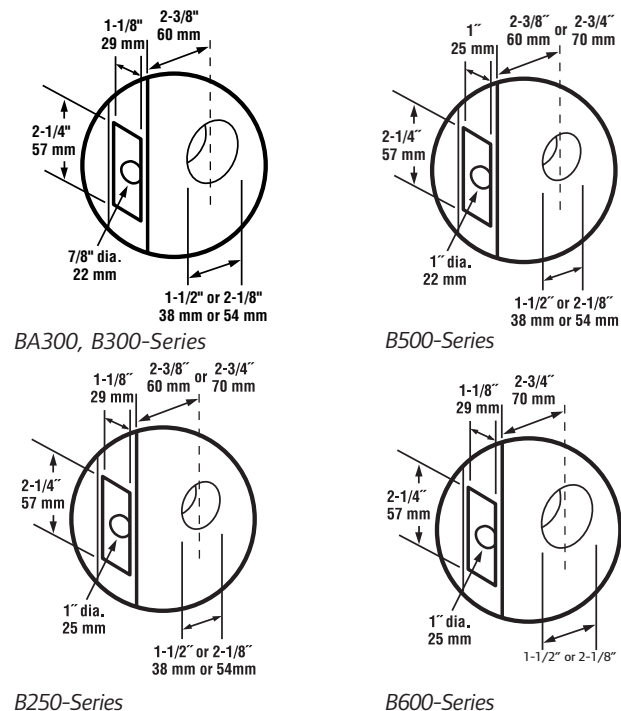



Leadership in Energy and Environmental Design.

Progress is Greener with Ingersoll Rand.

At Ingersoll Rand, Progress is Greener. As a global company, we are taking the initiative to offer environmentally friendly products to better support our communities' environmental needs.

In addition to offering environmentally friendly products, we will continually update and provide you with LEED information.

LEED, Leadership in Energy and Environmental Design, is a rating system that is designed to construct sustainable and energy efficient buildings, which in turn promotes a clean and sustainable environment. LEED certification focuses on 5 distinct areas of building performance: sustainable sites, water efficiency, energy and atmosphere, materials and resources, and indoor environmental quality.

From these 5 focus areas, a series of benchmarks is established for each and credits are awarded based on the completion of each benchmark.

As environmental awareness grows around the world, people are seeing the value in programs such as LEED. In addition to ensuring environmentally safe and sustainable buildings, becoming LEED certified has many incentives. National, state, and local governments are implementing LEED initiatives, in which they standardize LEED certification for all new construction. Some governments are also providing financial incentives for buildings that become LEED certified, such as discounted or fast track building permits.

Ingersoll Rand has recognized the value of the LEED rating system and we are continuing to provide you with information for various LEED credits.

Currently, many products offered by **Schlage, Von Duprin, LCN, Falcon, Monarch, and Dor-o-Matic** contribute to a project's LEED certification in the following credits:

Materials & Resources Credit 4.1- Recycled Content
Materials & Resources Credit 4.2- Recycled Content
Materials & Resources Credit 5.1- Regional Manufacture
Materials & Resources Credit 5.2- Regional Manufacture

For further information regarding LEED certification and how your next building can become certified, please visit the USGBC website <http://usgbc.org>.

Contact your local SSC representative for specific product information and details or additional Green-Building information.

Progress is greener with Ingersoll Rand





Ingersoll Rand's Security Technologies Sector is a leading global provider of products and services that make environments safe, secure and productive. The Sector's market-leading products include electronic and biometric access control systems; time and attendance and personnel scheduling systems; mechanical locks and portable security, door closers and exit devices, steel doors and frames, architectural hardware and technologies and services for global security markets.

www.ingersollrand.com