

Loading Instructions

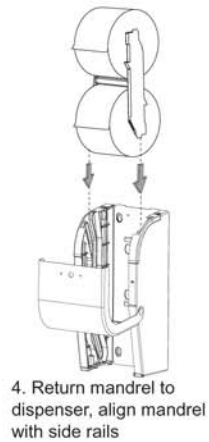

side

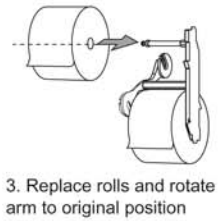
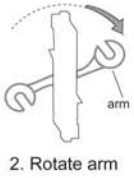
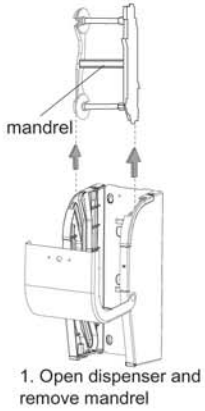
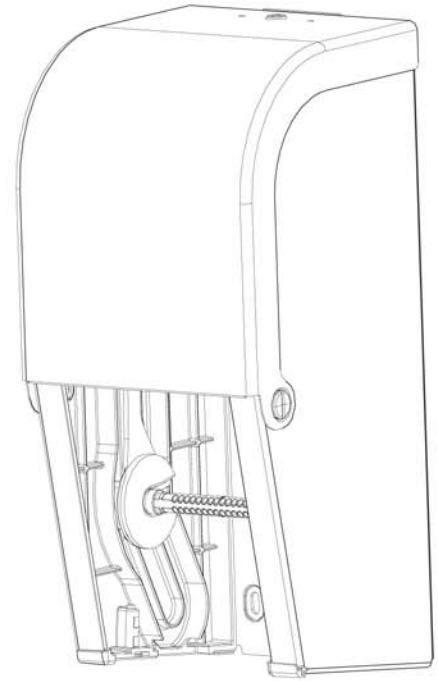
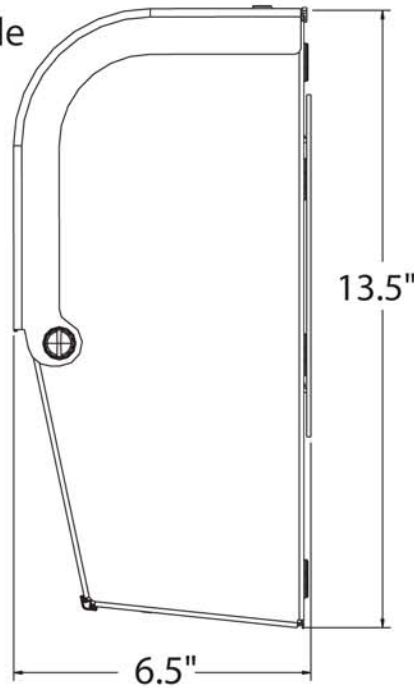

front

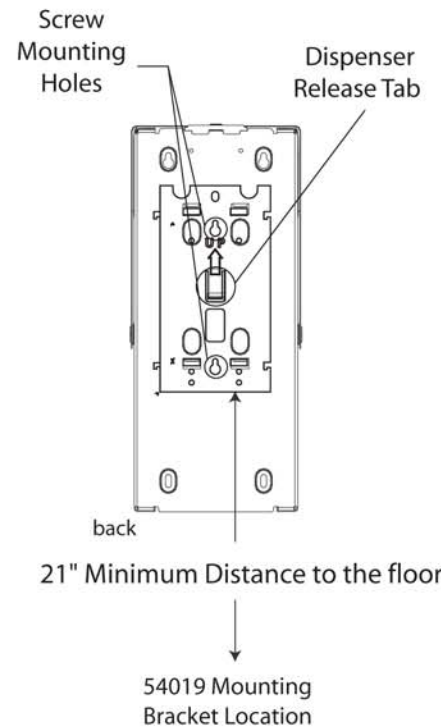
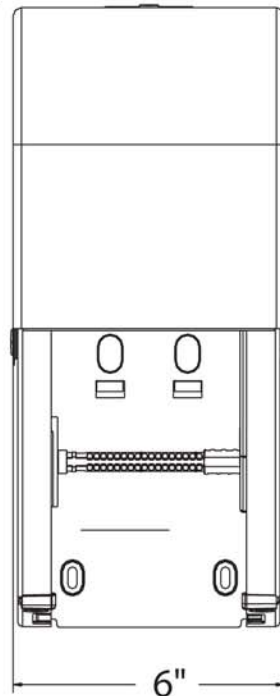

Overall Dimensions:

Dispenser: 6" W x 13.5" H x 6.5" D

Overall Weight:

Dispenser: 4.7 lbs (2.13kg)

Capacity: 2 rolls of Compact® 2-ply coreless bath tissue.

Specifications:

The cover and housing of the dispenser are constructed of formed stainless steel. The interior walls are constructed of ABS plastic.

For questions or comments, please call
1-866-HELLO GP (435-5647)